



HYDRAMAX™

high-performance hydraulic sprayers



Breakthrough Technology.

Higher Pressure.

Higher Output.

Longer Life.



Introducing HydraMax!

First to offer a hydraulic sprayer –
Graco does it again!

Graco released the first hydraulic sprayer in 1965 and began a tradition of leadership in the Hydraulic Airless Sprayer Market. And now that same tradition continues with the HydraMax line of Gas-Hydraulic Airless Sprayers. Utilizing state-of-the-art design features, HydraMax is the next generation in superior painting performance.

**THE FIRST
AND LAST WORD
IN HYDRAULIC
SPRAYERS!**

1965 EH™ 300/333



- 2-stage power system
- 1 hp electric motor
- Pressure up to 3000 psi (227 bar)
- Output up to 0.75 gpm (2.84 lpm)

1977 GH 433



- Direct immersion or siphon
- 4.6 hp engine
- Pressure up to 3000 psi (227 bar)
- Output up to 1.0 gpm (3.79 lpm)

2001 HydraMax



- Tip size up to .060
- 6.5, 9.0 or 11.0 hp Honda
- Pressure up to 4000 psi (276 bar)
- Output up to 3.5 gpm (13.25 lpm)

Look how far we've come!

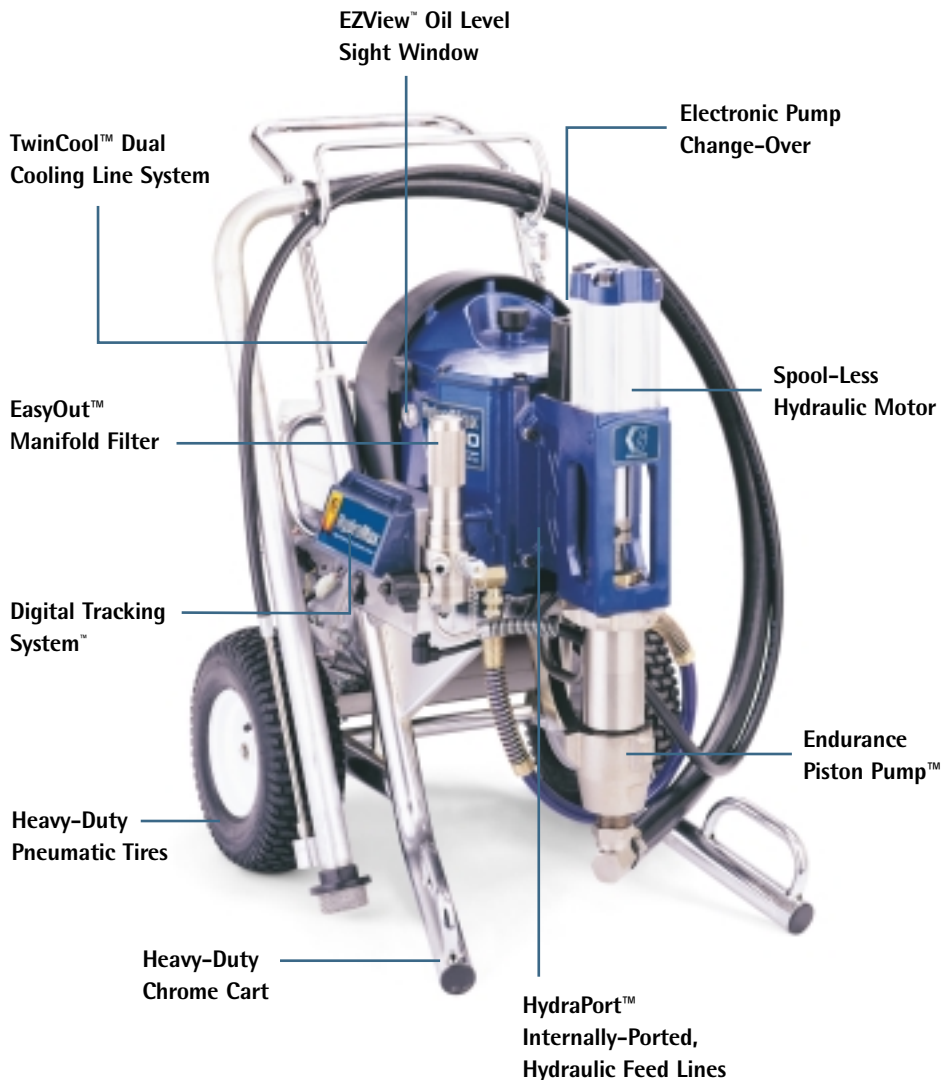

Revolutionizing the Hydraulic Sprayer

The list of industry-first features goes on and on...

TwinCool Dual Cooling Line System

- Two separate cooling lines provide maximum protection from heat
- Large 11" (279 mm) fan moves up to 400 cfm of cooling air



Electronic Pump Change-over

- Solenoid Actuated Directional Valve
- Fast and accurate timing of pump change-over
- More consistent pressure control
- Better atomization and fan pattern at the gun



EZView Oil Level Window

- At-a-glance oil checks are easy and accurate

Spool-Less Hydraulic Motor

- Fewer moving parts to wear
- Eliminates motor stalling

Large, All-Aluminum Hydraulic Reservoir

- 10 quart (9.46 l) capacity
- Dissipates heat up to 3 times more effectively than steel reservoirs

NEW Xtreme™ Pump Rod with Plasma Technology

- Longest life pumps
- Up to 3 times the life of chromed SST rods

Digital Tracking System

- Monitors sprayer pressure
- Counts job and lifetime gallons
- AutoClean™ Shut-off Timer



HydraPort™ Internally-Ported, Hydraulic Feed Lines

- Results in fewer potential leak points
- More efficient power transfer

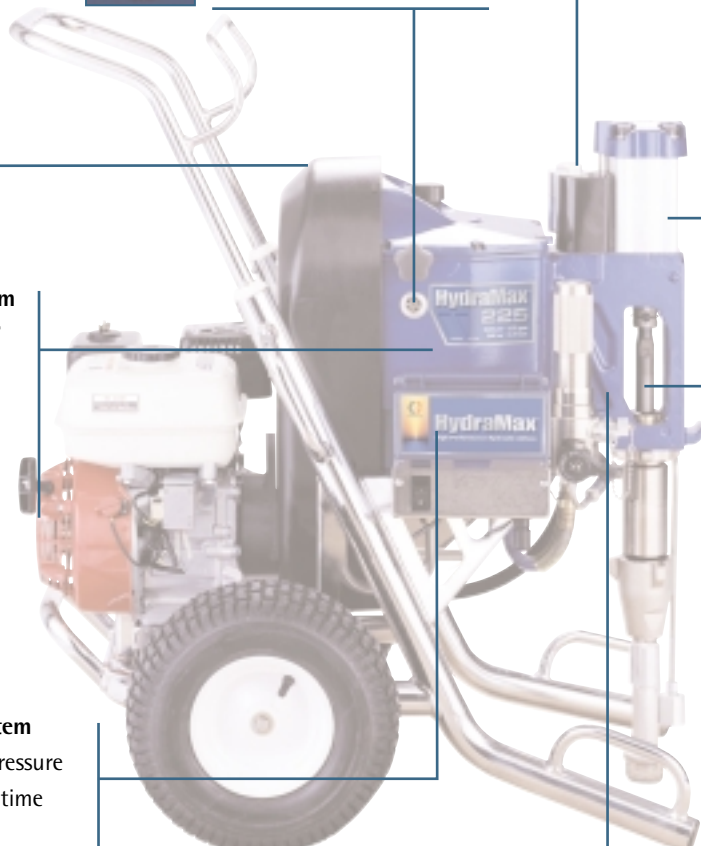

HIGHER PERFORMANCE

MORE FEATURES
MAXIMUM UPTIME



Breakthrough Performance

Designed to outperform the competition – PERIOD!

Each HydraMax has been designed with performance features that help you complete more projects and see better results. By coupling higher pressure with more output, you can run longer hose lengths, atomize heavier coatings, spray a wider range of materials and use a larger selection of tip sizes. In short, HydraMax instantly increases your productivity by completing more jobs in less time!

Higher Pressure

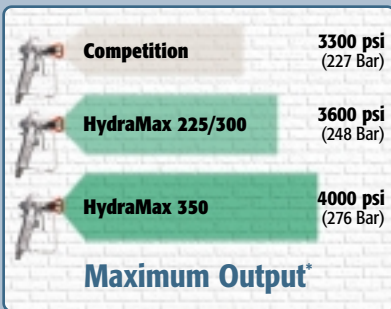

More Output

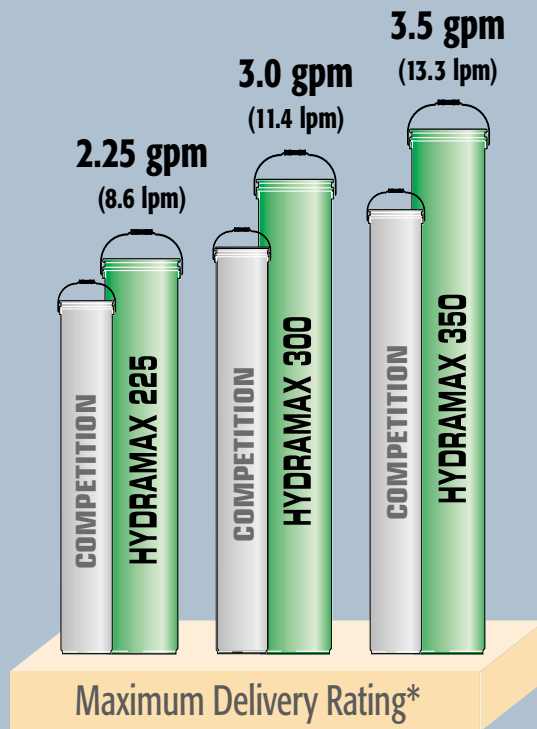

Larger Tips

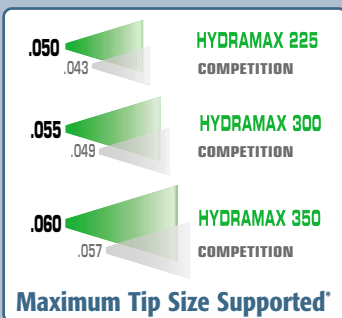

Maximum Results

- Run longer hose lengths
- Atomize heavier coatings
- Use larger tips
- Run multiple guns with larger true-to-the-application tip sizes
- **IMPROVE YOUR PRODUCTIVITY!**



No-Mess Fill Location

- Inset pool area catches spills for easy cleanup



TiltBack™ Bucket Exchange System

- Easily exchange material buckets without mess or the sprayer

*Illustrated results based on consistently tested gas-powered airless units, actual performance varies by model.

HIGHER PERFORMANCE MORE FEATURES MAXIMUM UPTIME



Innovative Features

Designed for the way you work

After spending countless hours with painting contractors, we designed HydraMax with your needs in mind. Every feature, from the no-mess fill location to the innovative Digital Tracking System, is designed to make your job easier and more productive.



Easy Out™ Filter

- Cleans from the inside out
- Never gets stuck



AutoClean Accessory Kit (optional)

- Reverse-flushing action cleans debris and paint from filters without removal
- AutoClean Shut-Off Timer automatically shuts off pump



QuikAccess™ Intake Valve

- Clear blockages in minutes
- No special tools required

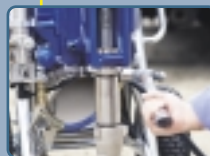

QuikChange™ Knock-Off Pump

- Remove pump quickly and easily
- Use tools you already have in your truck

HydraMax Digital Tracking System

With a large LCD display that's easily viewable, even in bright sunlight, the system puts never-before-available information at your fingertips!

Monitor spraying pressure



Recall previous pressure settings and easily adjust pressure for new coatings.

Count and reset job gallons



Easily track your material usage by individual jobs or multiple projects.

Track lifetime gallons used



Monitor sprayer life and schedule routine maintenance.

AutoClean shut-off timer



Count down timer works with the AutoClean Reverse Flushing System.†

† See Insert for details

HIGHER PERFORMANCE MORE FEATURES MAXIMUM UPTIME

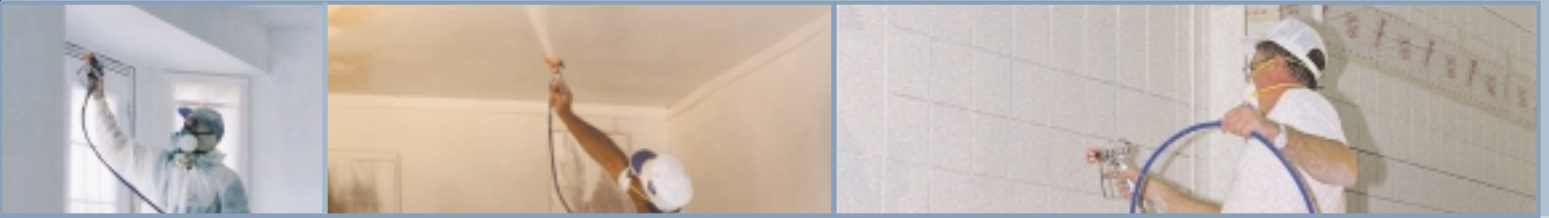

Unsurpassed Life

Setting new standards for dependability

HydraMax was tested on the most demanding of sites – the kinds of jobs that require minimal equipment downtime. Durability features like the Endurance Piston Pump and the innovative cooling system equip HydraMax for long days on any job, big or small.

Three Point Cooling System

A hydraulic system's #1 enemy is heat. It can break down hydraulic oil, weaken seals and eventually damage vital system components. Now HydraMax addresses this issue with its unique Three Point Cooling.

Introduced as the most advanced temperature management system available, it disperses damaging heat away from the unit, prolonging the life of your sprayer.

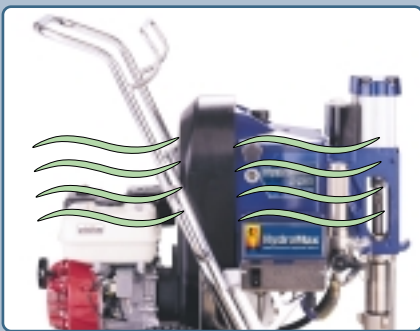

Large Aluminum Reservoir

- 10 quart (9.46 l) capacity
- Unique shape enables air flow to surround the reservoir on all sides – even the bottom



Large Fan Pulley

- Efficient 11" (27.94 cm) size
- Powerful fan feeds cool air across all components



TwinCool Dual Cooling Line System

- Increases life of hydraulic system components
- Heat is dissipated by main cooling line when sprayer is working its hardest
- Secondary line provides worry-free cooling when the sprayer is at stall

The Endurance Piston Pump

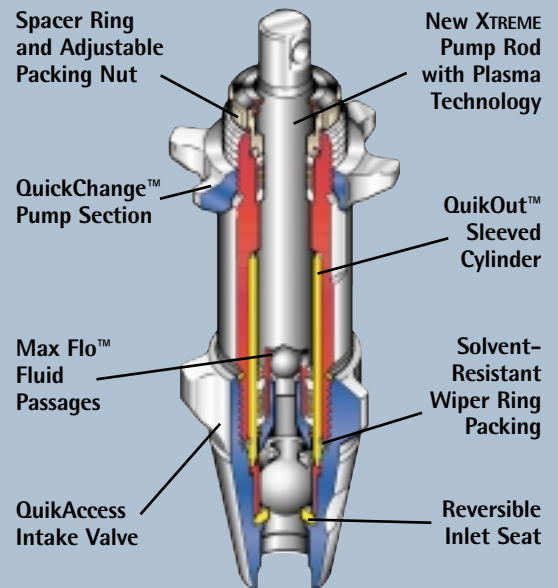

Unparalleled Pump Life



Our HydraMax Sprayers last up to twice as long as comparative models before you need to repack the pump. Valuable time savings like this can add up to *thousands* more gallons/liters of spraying each year.

Comparative Models

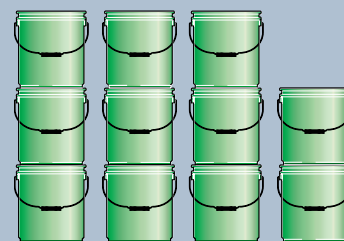

HydraMax Models

Illustrated life test results conducted on comparative gas-powered airless units with latex paint vs. HydraMax. Actual performance varies by model.

The New HydraMax Sprayers

Choose the model that's right for you

Graco offers a complete line of High Performance, HydraMax Hydraulic Sprayers. Whether you typically run single or multiple guns, common or exotic coatings, you are sure to find a HydraMax sprayer to help you complete your projects quickly and correctly. See the recommendation guide printed in the center insert to help you choose the sprayer that is best for you.



HydraMax 225 Direct Immersion
233640 Bare Sprayer
233642 Complete Sprayer*

HydraMax 225 Siphon

233641 Bare Sprayer
233643 Complete Sprayer*



HydraMax 300 Siphon

233650 Bare Sprayer
233651 Complete Sprayer*



HydraMax 350 Siphon

233660 Bare Sprayer
233661 Complete Sprayer**



**We build it.
We back it.
Period.**

- Easy-to-use warranty. No complicated paperwork!
- See instruction manual for full warranty*.

2-Year Bumper-to-Bumper Warranty

- We repair or replace any defective bare sprayer component for the original owner.
- Fluid pump components (parts and labor) limited to one-time replacements. Consumable items (filters, tips, etc.) are not covered.

30-Day "Just Add Paint" Replacement Guarantee

- Satisfied? If not, simply return sprayer within 30 days to your purchase place. Exchange it for an identical unit or trade-up to a larger unit at an additional cost.

Highest Resale Value

- Graco Sprayers typically receive a 20-30% higher resale value over competitors.

Downtime Eliminator™ Program

- Needed part (for warranty repair) not in your distributor's stock? Get FREE, next business day delivery, when distributor orders by 2 p.m. CST.
- Quik-Parts Plus Program offers 250+ parts 100% in stock.

Large Distributor Network

- 440+ certified service centers and 5400+ distributor locations for quick service with Graco parts, accessories and equipment in stock.

Assistance is just a phone call away

- Call 1-800-690-2894 for Customer Service.

* Includes: Silver Plus™ Gun, RAC™ 5 SwitchTip™ (.517), HandTite™ Guard, 3/8 in x 50 ft (9.5 mm x 15.2 m) Airless Hose, 3 ft (.9 m) Whip Hose and Swivel

** Includes: HD Texture Gun, Heavy-Duty RAC Tip (.631), Heavy-Duty RAC Guard, 3/8 in x 50 ft (9.5 mm x 15.2 m) 5000 psi (345 bar) Hose, 3 ft (.9 m) Whip Hose and Swivel

* Outside of the U. S. and Canada, not all conditions of the extended warranty may apply. Contact your local distributor for details.

ABOUT GRACO

Founded in 1926, Graco is a world leader in fluid handling systems and components. Graco products move, measure, control, dispense and apply a wide range of fluids and viscous materials used in vehicle lubrication, commercial and industrial settings.

The company's success is based on its unwavering commitment to technical excellence, world-class manufacturing and unparalleled customer service. Working closely with qualified distributors, Graco offers systems, products and technology which set the quality standard in a wide range of fluid handling solutions. Graco provides equipment for spray finishing, protective coating, paint circulation, lubrication, and dispensing sealants and adhesives, along with power application equipment for the contractor industry. Graco's ongoing investment in fluid management and control will continue to provide innovative solutions to a diverse global market.

GRACO HEADQUARTERS

AMERICAS

MINNESOTA
Worldwide Headquarters
Graco Inc.
88 - 11th Avenue N.E.
Minneapolis, MN 55413

MAILING ADDRESS:
P.O. Box 1441
Minneapolis, MN 55440-1441
Tel 612 623-6000
Fax 612 623-6777

EUROPE

BELGIUM
European Headquarters
Graco N.V.
Industrieterrein - Oude Bunders
Slakweidestraat 31
3630 Maasmechelen
Belgium
Tel 32 89 770 700
Fax 32 89 770 777

ASIA PACIFIC

JAPAN
Graco K.K.
1-27-12 Hayabuchi
Tsuzuki-ku
Yokohama City, Japan 224-0025
Tel 81 45 593 7300
Fax 81 45 593 7301

CHINA
Graco Hong Kong Ltd.
Representative Office, Room 1809,
No. 509 Cao Bao Road
New Cao He Jing Tower
Shanghai, P.R.China 200233
Tel 86 21 649 50088
Fax 86 21 649 50077

KOREA
Graco Korea Inc.
3rd Fl., Doorim Bldg.
164-21 Poi-Dong,
Kangnam-Ku
Seoul, Korea 135-260
Tel 82 2 575-8901
Fax 82 2 571-9422



Get Graco. Experience the Difference.™

Graco Inc. is registered to I.S. EN ISO 9001

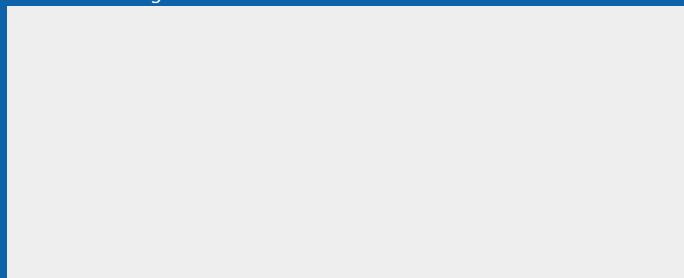

Sales/Distribution Toll Free, North America
800-690-2894
FAX 800-334-6955
www.graco.com



GRACO INC.
P.O. Box 1441
Minneapolis, MN 55440-1441

HydraMax™ Accessories

Airless Tips and Guards

RAC™ 5 SwitchTip™ 286XXX (black)

- OneSeal™ — compatible with both latex and solvent-based materials
- Arrow-shaped, ergonomic handle
- Easy assembly without tools
- Spray lacquers to mastics
- Working Pressure - 4050 psi (279 bar, 27.9 MPa) max.

Fine Finish RAC 5 Tip FF5XXX (green)

- Spray lacquers, varnishes, stains and high finish enamels
- Dual orifice tip for finer finish at low pressures with less overspray
- Working Pressure - 4050 psi (279 bar, 27.9 MPa) max.

Contractor™ Flat Tip 269XXX

- Tungsten carbide orifice resists wear due to abrasive coatings
- Working Pressure - 5000 psi (345 bar, 34.5 MPa) max.

HandTite™ Tip Guards

243161 For 7/8 in. (22 m) thread size. Fits Graco and Titan Guns.

243263 For 11/16 in. (17 m) thread size. Fits some Wagner, Airlessco and ASM Guns.

Flat Tip Guards

220251 For 7/8 in. (22 mm) thread size. Fits Graco and Titan Guns.

220255 For 11/16 in. (17 mm) thread size. Fits some Wagner, Airlessco and ASM Guns.

Gun Hose Kits

244924 HydraMax 225/300 Gun Hose Kit

Includes: Silver Plus™ Gun, RAC 5 SwitchTip (.517), HandTite Guard, 3/8 in. x 50 ft. (9.5 mm x 15.2 m) 3600 psi (248 bar, 24.8 MPa) Airless Hose and 3 ft. (0.9 m) Whip Hose with Swivel.

244925 HydraMax 350 Gun Hose Kit

Includes: Heavy-Duty Texture Gun, Heavy-Duty RAC Tip (.631), Heavy-Duty RAC Guard, 3/8 in. x 50 ft. (9.5 mm x 15.2 m) 5000 psi (345 bar, 34.5 MPa) Airless Hose and 3 ft. (0.9 m) Whip Hose with Swivel.

BLUE MAX™ HP High-Pressure Hose

- Increased working pressure: 3600 psi (248 bar, 24.8 MPa) max.
- Less pressure drop for higher performance at the gun

244926 1/4 in. x 3 ft. (6.3 mm x 0.9 m) MxF Whip

244339 1/4 in. x 50 ft. (6.3 mm x 15.2 m) FBE

244340 3/8 in. x 50 ft. (9.5 mm x 15.2 m) FBE

Suction Tube Kits

245242 Direct Immersion Kit for HydraMax 225

245249 Siphon Kit for HydraMax 225*

245250 Siphon Kit for HydraMax 300 and 350*

* Kits work with containers up to 55 gal (208 L). Adapt suction tube to fit your container.

Filters

Easy Out™ Filters (Long) - 1 Pack

244071 30 Mesh (grey)

244067 60 Mesh (black)

244068 100 Mesh (blue)

244069 200 Mesh (red)

Tip Filters

238561 3 pack (100 mesh)

224453 5 pack (100 mesh)

224454 5 pack (60 mesh)

238564 25 pack (60 mesh)

164120 Tip Filter Housing

Gun Filters - 1 per Card

218131 50 Mesh (blue)

218133 100 Mesh (red)



Gun Filters



HydraMax 225/300 Gun Hose Kit



BlueMax HP High-Pressure Hose



Easy-Out Filter

CONTINUED ON BACK PAGE

Sprayer Recommendation Guide

Choose the HydraMax sprayer that best fits your needs. Check with your material supplier to be sure the material you're spraying is compatible with your new sprayer.

		HydraMax 225
Maximum Tip Size		1 gun: 0.050 2 guns: 0.035 3 guns: 0.029 4 guns: 0.025
Maximum Delivery Rating		2.25 gpm (8.6 lpm)
Maximum Working Pressure		3600 psi (248 bar, 24.8 MPa)
Maximum Hose Length		300 ft. (91.4 m)
Engine		6.5 HP Honda
Fuel Tank Capacity		0.95 gal (3.6 L)
Weight		229 lb (104 kg)
Dimensions	inches (centimeters)	24.5 W x 35 L x 34 H (62.23 W x 88.9 L x 86.36 H)
Pump Repair Kit		244955
Operation Manual		309378
Repair Manual		309379

Revolutionary AutoClean™

Changing the way you think about clean-up!

There's still one job left once you've finished spraying – and that's clean-up. AutoClean simplifies clean-up by reducing it to a few easy steps that save time and reduce mess. Graco is the first to provide you with this time-saving solution to clean-up with innovations like reverse flushing and the AutoClean Shut-off Timer. The AutoClean Shut-off Timer cleans and stops automatically, making cleaning your sprayer a snap!

See how reverse flow cleans

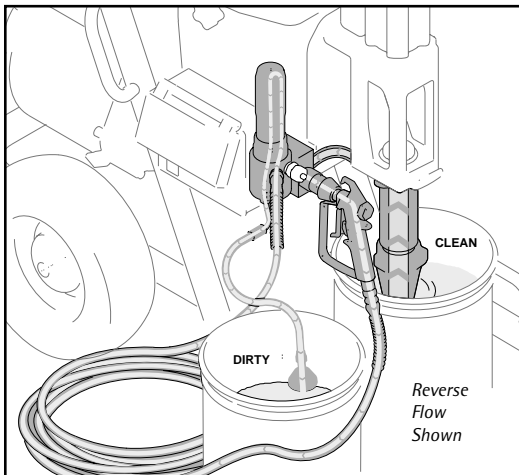

Reverse flow cleans debris and paint from filters without removal.

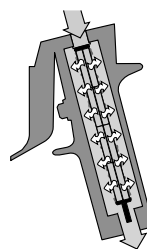

Gun Filter

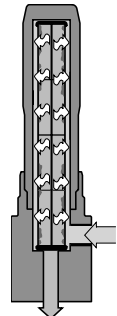

Pump Filter

HydraMax 300	HydraMax 350
1 gun: 0.055 2 guns: 0.037 3 guns: 0.031 4 guns: 0.027	1 gun: 0.060 2 guns: 0.041 3 guns: 0.033 4 guns: 0.029
3.0 gpm (11.4 lpm)	3.5 gpm (13.3 lpm)
3600 psi (248 bar, 24.8 MPa)	4000 psi (276 bar, 27.6 MPa)
300 ft. (91.4 m)	300 ft. (91.4 m)
9.0 HP Honda	11.0 HP Honda
1.59 gal (6.0 L)	1.72 gal (6.5 L)
279 lb (127 kg)	294 lb (134 kg)
24.5 W x 38 L x 36 H (62.23 W x 96.52 L x 91.44 H)	24.5 W x 38 L x 36 H (62.23 W x 96.52 L x 91.44 H)
244958	244958
309378	309378
309379	309379

Just FIVE easy steps!

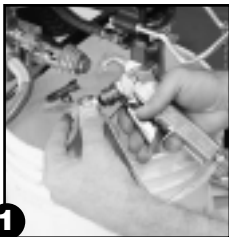

1

Remove the tip and the guard from the gun and open the prime valve.



2

Screw the gun into the AutoClean Valve.

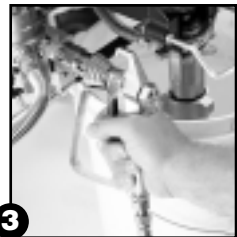

3

Once connected, push and twist to lock open the AutoClean Valve.



4

Lock the gun trigger into the open position with the trigger clamp provided.



5

Set the AutoClean Shut-off Timer and walk away. AutoClean flushes the sprayer then shuts off automatically. It's that easy!

Airless Guns

Contractor™ Gun

- 243282 Includes RAC 5 (.517) SwitchTip and HandTite Tip Guard
- 179943 Optional 4-Finger Trigger available
- Working Pressure: 3600 psi (248 bar, 24.8 MPa) max.
- 218070 Repair Kit



Contractor FTx™ Gun

- 243285 Includes RAC 5 (.515) SwitchTip and HandTite Tip Guard
- Working Pressure: 3600 psi (248 bar, 24.8 MPa) max.
- 218070 Repair Kit

Silver Plus™ Gun

- 243283 2-Finger Trigger with RAC 5 (.517) SwitchTip and HandTite Tip Guard
- 235460 2-Finger Trigger with Flat Tip Guard
- 235461 4-Finger Trigger with Flat Tip Guard
- 235462 Fine Finish with 2-Finger Trigger and Flat Tip Guard
- Working Pressure: 5000 psi (345 bar, 34.5 MPa) max.
- 235474 Repair Kit



Heavy-Duty Texture Gun

- 241705 Heavy-Duty Texture Gun with GHD631 Spray Tip and Heavy-Duty RAC 5 Tip Guard
- Ideal for high solids, mastics, protective coatings and smooth textures
- Stainless steel fluid tube
- Fluid Orifice diameter: 0.125 in. (3.2 mm)
- 237260 Repair Kit
- Working Pressure: 4000 psi (276 bar, 27.6 MPa) max.



Extensions and Pole Guns

Tip Extensions

- 243295 10 in. (25 cm)
- 243296 15 in. (38 cm)
- 243297 20 in. (50 cm)
- 243298 30 in. (75 cm)
- Includes HandTite Tip Guard standard with 7/8 in. (22 mm) gun nut. Fits Graco and Titan Guns.
- 181085 For Wagner or other guns, order 1/16 in. (17 mm) gun nut adapter.



Heavy-Duty Extensions

- 232121 10 in. (25 cm)
- 232122 20 in. (50 cm)
- 232123 40 in. (100 cm)
- 232124 60 in. (150 cm)
- 232125 80 in. (200 cm)
- Standard with 7/8 in. (22 cm) gun nut. Fits Graco or Titan Guns.
- For Wagner or other guns using 1/16 in. (17 mm) gun nut, order part no. 181085 gun adapter.



Pole Guns

- 244057 3 ft. (0.9 m) Pole Gun
- 244058 6 ft. (1.8 m) Pole Gun
- Includes RAC 5 (.517) SwitchTip and HandTite Guard
- Maximum Working Pressure: 3600 psi (248 bar, 24.8 MPa)
- 244160 CleanShot™ Shut-Off Valve
- 244162 CleanShot Shut-Off Valve Repair Kit
- 244363 CleanShot Swivel
- Working Pressure: 500 to 3600 psi (34.5 to 248 bar, 3.5 to 24.8 MPa)
- 244161 Contractor In-Line Valve
- 218070 In-Line Valve Repair Kit
- Uses Contractor Gun Filters 218131 (50 mesh) and 218133 (100 mesh)
- Working Pressure: 3600 psi (248 bar, 24.8 MPa) max.



AutoClean™ Accessory Kit

- 245159 Easy-to-Install AutoClean System
- Upgrade your HydraMax Sprayer to include the AutoClean Reverse-Flushing System. The AutoClean System saves you time and reduces mess during cleanup.



GRACO INC.
P.O. Box 1441
Minneapolis, MN 55440-1441