

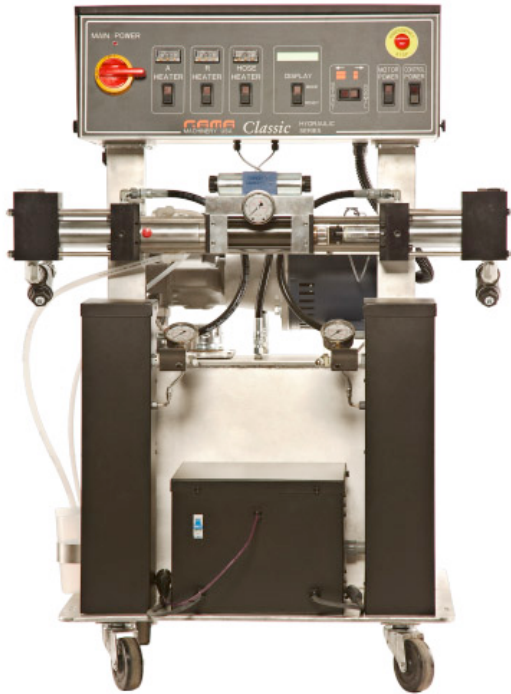

POLYURETHANE MACHINERY CORPORATION



Classic GH-40 Proportioner

Manual
Ref. # MN-05002

January 1, 2011

Polyurethane Machinery Corp.

Headquarters: 1 Gusmer Drive, Lakewood NJ 08701

Manufacturing: 2 Gusmer Drive, Lakewood, NJ 08701

Phone: 732-415-4400 Fax: 732-370-7186

<http://www.polymac-usa.com>



Before installing the GH Series Proportioner and start-up, carefully read all the technical and safety documentation included in this manual. Pay special attention to the information in order to know and understand the operation and the conditions of use of the GH Series Proportioner. All of the information is aimed at improving user safety and avoiding possible breakdowns from the incorrect use of the GH Series Proportioner.



Classic GH-40 Manual

WARRANTY

Polyurethane Machinery Corporation (hereinafter “PMC”) provides this **LIMITED WARRANTY** (hereinafter “Warranty”) to the original purchaser (hereinafter “Customer”) covering this equipment and the original PMC manufactured accessories delivered with the equipment (hereinafter “Product”) against defects in material or workmanship of the Product (hereinafter “Defect” or “Defective”) for a period of one (1) year from the date of first purchase as shown on the original PMC invoice (hereinafter “Warranty Period”).

If during the Warranty Period under normal use, the Product is suspected by Customer to be Defective in material or workmanship, it is Customer’s responsibility to contact PMC and return the Product to PMC as directed by PMC, freight prepaid. If PMC determines that the Product is Defective and that such Defect is covered by this Warranty, PMC will credit Customer for the reasonable freight charges incurred by Customer in returning the Defective Product to PMC, and PMC (or its authorized agent) will, at PMC’s option, repair or replace the Product, subject to the following:

Original Invoice: The original invoice must be kept as proof of the date of first sale and the Product serial number. The Warranty does not cover any Product if the Original Invoice appears to have been modified or altered, or when the serial number on the Product appears to have been altered or defaced.

Product Maintenance: It is the Customer’s responsibility to maintain the Product properly. See your maintenance schedule and owner’s manual for details. The Warranty does not cover an improperly maintained Product.

Non-PMC Components and Accessories: Non-PMC manufactured components and accessories that are used in the operation of the Product are not covered by this Warranty. Such components and accessories shall be subject to the warranty offered to the Customer, if any, by the original manufacturer of such component or accessory.

Other Warranty Exclusions: The Warranty does not cover any Product that PMC determines has been damaged or fails to operate properly due to misuse, negligence, abuse, carelessness, neglect, or accident. By way of example only, this includes:

- Normal wear and tear.
- Improper or unauthorized installation, repair, alteration, adjustment or modification of the Product.
- Use of heating devices, pumping equipment, dispensers, or other parts or accessories with the Product that have not been approved or manufactured by PMC.
- Failure to follow the operating instructions and recommendations provided by PMC.
- Cosmetic damage.
- Fire, flood, “acts of God,” or other contingencies beyond the control of PMC.

WARRANTY (cont)

THE WARRANTY DESCRIBED HEREIN IS THE EXCLUSIVE REMEDY FOR THE CUSTOMER AND IS IN LIEU OF ALL OTHER WARRANTIES, EXPRESS, IMPLIED, STATUTORY OR OTHERWISE, AND THE IMPLIED WARRANTIES OF MERCHANTABILITY AND FITNESS FOR A PARTICULAR PURPOSE AND ALL OTHER WARRANTIES ARE HEREBY DISCLAIMED. TO THE FULLEST EXTENT PERMITTED BY LAW, PMC SHALL NOT BE RESPONSIBLE, WHETHER BASED IN CONTRACT, TORT (INCLUDING, WITHOUT LIMITATION, NEGLIGENCE), WARRANTY OR ANY OTHER LEGAL OR EQUITABLE GROUNDS, FOR ANY CONSEQUENTIAL, INDIRECT, INCIDENTAL, LOST PROFITS, SPECIAL, PUNITIVE OR EXEMPLARY DAMAGES, WHETHER TO PERSON OR PROPERTY, ARISING FROM OR RELATING TO THE PRODUCT, EVEN IF PMC HAS BEEN ADVISED OF THE POSSIBILITY OF SUCH LOSSES OR DAMAGES.

Non-Warranty Service by PMC: If PMC determines that the suspected Defect of the Product is not covered by this Warranty, disposition of the Product will be made pursuant to the terms and conditions of PMC's written estimate on a time and materials basis.

Continuing Warranty for Products Repaired or Replaced under Warranty: Following the repair or replacement of a Product covered by this Warranty, such Product will continue to be subject to the original Warranty for the remainder of original Warranty Period or for three (3) months from the repair or replacement date, whichever is longer.

No Rights Implied: Nothing in the sale, lease or rental of any Product by PMC shall be construed to grant any right, interest or license in or under any patent, trademark, copyright, trade secret or other proprietary right or material owned by anyone; nor does PMC encourage the infringement of same.

Exclusive Warranty: This writing is the final, complete, and exclusive expression of the Warranty covering the Product. Any statements made by PMC, its employees or agents that differ from the terms of this Warranty shall have no effect. It is expressly understood that Customer's acceptance of this Warranty, by performance or otherwise, is upon and subject solely to the terms and conditions hereof, and any additional or different terms and conditions proposed or expressed by Customer or anyone, whether in writing or otherwise, are null and void unless specifically agreed to in writing by an Officer of PMC.



Classic GH-40 Manual

Warranty	2
Safety and Handling	5
Characteristics	
Principal Heating System	7
Hose Heating System	7
Double Acting Opposed Piston Metering Pumps	7
Technical specifications	
Electrical	8
Mechanical	8
Description	9
Installation	13
Proportioner Purging	18
Digital Temperature Controller	19
Start-Up	20
Shutdown Procedures	21
Troubleshooting	22
Heaters	23
Hydraulic Drive System.....	26
Metering Pump Line.....	28
Hose Heating	32
Maintenance	34
Inlet Material Screens	35
Iso Lubrication System.....	36
Hydraulic Drive System	36
Metering Pump Line	37
Material Heater	38
Replacement Kits	40
Hydraulic Oil Specification	43
Parts Identification	
Pump Line Assembly	44
Iso (A) Pump Line -120.....	46
Poly ® Pump Line -120.....	47
Iso (A) Pump Line -80.....	48
Poly ® Pump Line -80.....	49
Hydraulic Cylinder.....	50

SAFETY AND HANDLING

This chapter contains important information on the safety, handling and use of your *Classic* GH Series Proportioner.



Before installing the GH Series Proportioner and start-up, carefully read all the technical and safety documentation included in this manual. Pay special attention to the information to know and understand the operation and the conditions of use of the GH Series Proportioner. All of the information is aimed at enhancing User Safety and avoiding possible breakdowns derived from the incorrect use of the GH Series Proportioner.

WARNING! presents information to alert of a situation that might cause serious injuries if the instructions are not followed.

CAUTION! presents information that indicates how to avoid damage to the Proportioner or how to avoid a situation that could cause minor injuries.

NOTE: is relevant information of a procedure being carried out.

Careful study of this manual will enable the operator to know the characteristics of the GH Series Proportioner and the operating procedures. By following the instructions and recommendations contained herein, you will reduce the potential risk of accidents in the installation, use or maintenance of the GH Series Proportioner; you will provide a better opportunity for incident-free operation for a longer time, greater output and the possibility of detecting and resolving problems fast and simply.

Keep this Operations Manual for future consultation of useful information at all times. If you lose this manual, ask for a new copy from your PMC Service Center, directly contact PMC or on line at our web site (www.polymac-usa.com).

The *Classic* GH Series Proportioner has been designed and built for the application of polyurea chemical systems, polyurethane foam chemical systems and some two-component epoxy systems.

WARNING! *The design and configuration of the GH Series Proportioner does not allow its use in potentially explosive atmospheres or the pressure and temperature limits described in the technical specifications of this manual to be exceeded.*

Always use liquids and solvents that are compatible with the unit. If in doubt, consult PMC Technical Service.

When working with the GH Series Proportioner, it is recommended that the operator wear suitable clothing and elements of personal protection, including, without limitation, gloves, protective goggles, safety footwear and face masks. Use breathing equipment when working with the GH Series Proportioner in enclosed spaces or in areas with insufficient ventilation. The introduction and follow-up of safety measures must not be limited to those described in this manual. Before starting up the GH Series Proportioner, a comprehensive analysis must be made of the risks derived from the products to be dispensed, the type of application and the working environment.



Classic GH-40 Manual

SAFETY AND HANDLING (cont)



To prevent possible injury caused by incorrect handling of the raw materials and solvents used in the process, carefully read the Material Safety Data Sheet (MSDS) provided by your supplier.

Deal with waste caused according to current regulations.

Pour éviter toute blessure causée par une mauvaise manipulation des matières premières et les solvants utilisés dans le processus, veuillez lire attentivement la fiche signalétique (MSDS) fournies par votre fournisseur.

Traiter les déchets causés selon la réglementation en vigueur.



To avoid damage caused by the impact of pressurized fluids, do not open any connection or perform maintenance work on the components subject to pressure until the pressure has been completely eliminated.

Pour éviter les dommages causés par l'impact des fluides sous pression, ne pas ouvrir un lien ou d'effectuer des travaux d'entretien sur les éléments soumis à la pression jusqu'à ce que la pression a été complètement éliminé.



Use suitable protection when operating, maintaining or being present in the area where the equipment is functioning. This includes, but is not limited to, the use of protective goggles, gloves, shoes and safety clothing and breathing equipment.

Utiliser une protection appropriée utilisation, d'entretien ou d'être présents dans la région où le matériel fonctionne. Cela inclut, mais n'est pas limité à, l'utilisation de lunettes de protection, gants, chaussures et vêtements de sécurité et un équipement respiratoire.



The equipment includes components that reach high temperatures and can cause burns. Hot parts of the equipment must NOT be handled or touched until they have cooled completely.

L'équipement comprend des éléments qui atteignent des températures élevées et peuvent provoquer des brûlures. Les parties chaudes de l'équipement ne doit pas être manipulé ou touché jusqu'à ce qu'ils aient complètement refroidi.



To prevent serious injury through crushing or amputation, do not work with the equipment without the safety guards installed on the moving parts. Make sure that all the safety guards are correctly reinstalled at the end of the repair or maintenance work of the equipment.

L'équipement comprend des éléments qui atteignent des températures élevées et peuvent provoquer des brûlures. Les parties chaudes de l'équipement ne doit pas être manipulé ou touché jusqu'à ce qu'ils aient complètement refroidi.

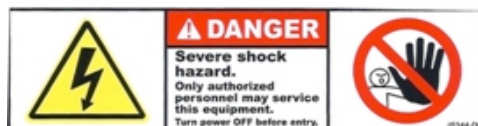

CHARACTERISTICS

The *Classic* GH Proportioner has been designed and built for the application of polyurea chemical systems, polyurethane foam chemical systems and some specific two-component epoxy systems.

Principal Heating System

The Proportioner consists of two (2) independent Material Heaters without internal seals. Each Heater has six (6) Heating Elements rated 1,250 watts each (1,500 watts optional) giving the Proportioner a total heat of 15,000 watts (18,000 watts optional) and the necessary control and safety components for their precise operation. The Material Heater design allows a temperature differential (ΔT) of 90° F and material application temperatures of up to 190° F under normal ambient temperatures.

Hose Heating System

The system is designed with a 5 KVA Isolation Transformer that enables effective heating of up to a total hose length of 410 feet. The system includes an innovative hose heating concept in which the continuous braid tinned-copper jacket is distributed evenly around the circumference of the hose providing a uniform heating watt density and precise control of the material application temperature. This hose heating element design is extremely resistant to fatigue failure.

100% circumferential coverage produces the most uniform distribution of heat available.

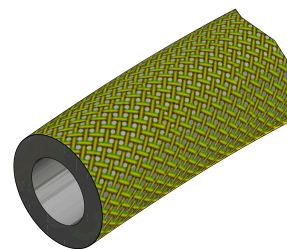

It is recommended to use PMC manufactured hose with all Classic Proportioners to get maximum Hose Heat operation.

Low Pressure Hoses

Part # MA-00014A

Part # MA-00014A-TC

High Pressure Hoses

Part # MA-00038A

Part # MA-00038A-TC

Double Acting Opposed Piston Metering Pumps

The opposed double acting Pump Line is driven by a dual rod Hydraulic Cylinder. The in-line pump system with opposed piston pumps provides a constant volume and guarantees uniform pressures in both directions of pump movement. Different sized pumps allow for various volumetric ratios to be achieved (1:4 to 1:1 to 4:1) between the chemical components used in the process.



Classic GH-40 Manual

TECHNICAL SPECIFICATIONS

Electrical

Main voltage: _____ 3 x 208-230V, 50/60Hz
 Main voltage: _____ 1 x 208-230V, 50/60Hz
 Electrical consumption: (2 x 7.5 kW Heater) _____ 80 A @ 3 x 230V
 Electrical consumption: (2 x 9 kW Heater) _____ 93 A @ 3 x 230V
 Electrical consumption: (2 x 7.5kW Heater) _____ 130 A @ 1 x 230V
 Material Heater Power: _____ (2 X 7.5 kW) 15 kW
 Material Heater Power (optional): _____ (2 X 9 kW) 18 kW
 Hose Transformer Power: _____ 5 KVA
 Electrical Motor Power: _____ 5 hp



CAUTION! Inside the console, is a Terminal Strip for connecting the main power (wire not supplied) to the GH Series Proportioner. Use the appropriate AWG wire. This electrical connection must be made only by a qualified electrician.

Mechanical

Maximum working pressure (with 120 pumps): _____ 2,000 psi
 Use PMC Low Pressure Heated Hoses: MA-00014A and MA-00014A-TC
 Maximum working pressure (with 80 pumps): _____ 3,000 psi
 Use PMC High Pressure Heated Hoses: MA-00038A and MA-00038A-TC
 Maximum production ratio 1:1 (with 120 pumps): _____ 40 lb/min
 Maximum production ratio 1:1 (with 80 pumps): _____ 2.5 gpm
 Minimum production: _____ 2 lb/min
 Maximum hose length: _____ 410 ft
 Approximate weight (Hydraulic Tank empty): _____ 550 lbs
 Approximate weight (Hydraulic Tank full @ 20 gal): _____ 700 lbs
 Dimensions: _____ 30in W x 26in D x 45in H

NOTE: The Classic Series is designed to be used with the PMC AP-1 Spray Gun (3500 PSI) or equivalent that is rated to the maximum pressure rating of the Classic model being used. Refer to manual # MN-04002.

DESCRIPTION

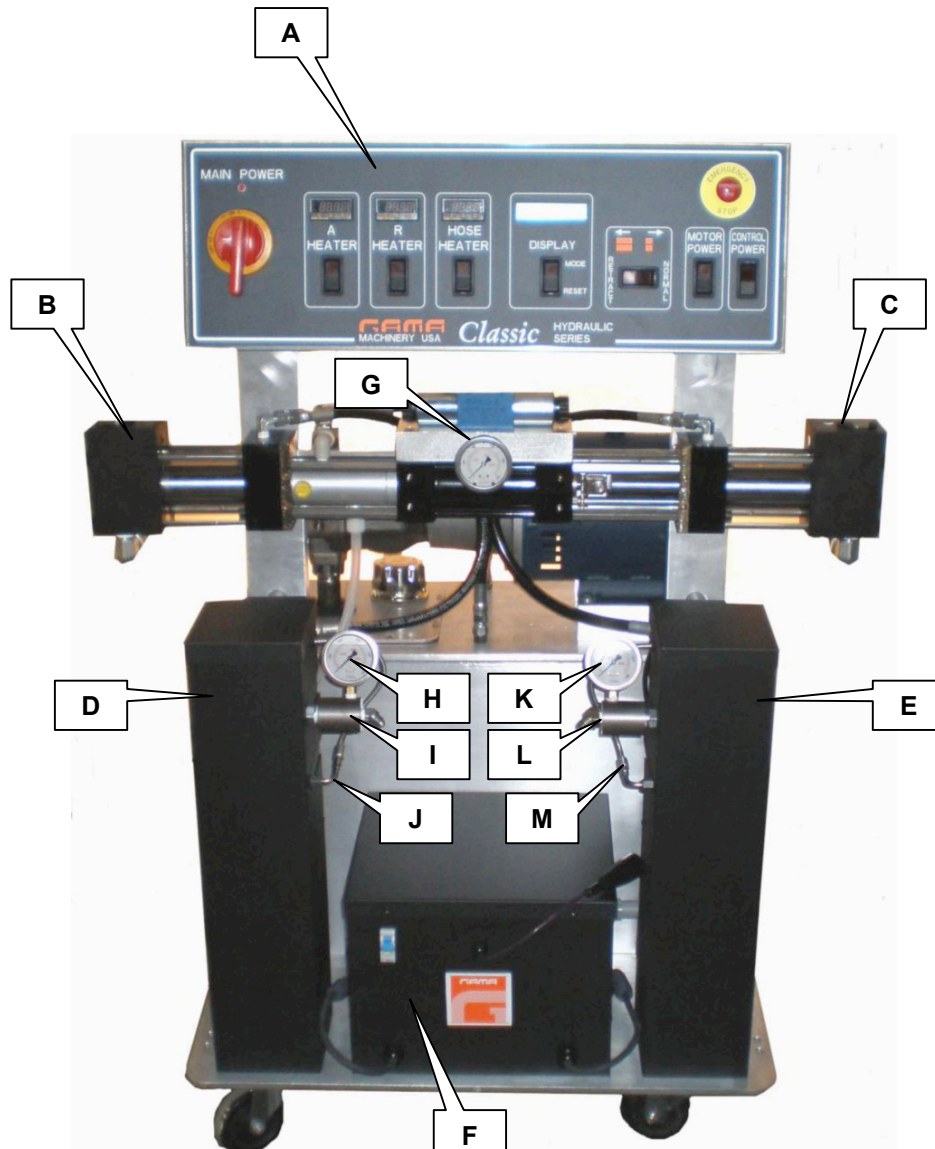

Figure 1

Classic GH-40 (Shown)

- A. Control Panel**
Controls and regulates the operation of the GH Series Proportioner
- B. Isocyanate (Iso, A) Metering Pump**
Meters the Isocyanate material



Classic GH-40 Manual

DESCRIPTION (cont)

- C.** Polyol (Poly, R) Metering Pump
Meters the Polyol material
- D.** Isocyanate (Iso, A) Heater
Heats the incoming Isocyanate to a temperature set by the operator
- E.** Polyol (Poly, R) Heater
Heats the incoming Polyol to a temperature set by the operator
- F.** Hose Heating Transformer
Supplies the required voltage for material Heated Hoses
- G.** Hydraulic Pressure Gage
Indicates the pressure in the Hydraulic Drive System
- H.** Isocyanate (Iso, A) Pressure Gage
Indicates the pressure in the Isocyanate system
- I.** Isocyanate (Iso, A) Safety Pressure Switch
Turns OFF the Directional Valve in the event of excessive pressure in the Isocyanate system
- J.** Isocyanate (Iso, A) Thermocouple
Provides temperature information of the Isocyanate to its Temperature Controller
- K.** Polyol (Poly, R) Pressure Gage
Indicates the pressure in the Polyol system
- L.** Polyol (Poly, R) Safety Pressure Switch
Turns OFF the Directional Valve in the event of excessive pressure in the Polyol system
- M.** Polyol (Poly, R) Thermocouple
Provides temperature information of the Polyol to its Temperature Controller
- N.** Hydraulic Pressure Control
Allows the pressure of the hydraulic system to be increased or decreased. Turn clockwise to increase the pressure and counterclockwise to decrease. To regulate the pressure of the hydraulic system, the NORMAL or RETRACT Pump Switch position must be selected
- O.** Inlet Material Strainer (not shown)
Screens (40 mesh) material from bulk supply

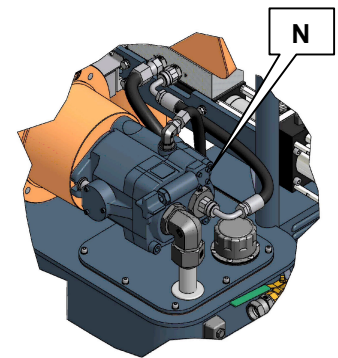

Figure 2
Hyd. Pressure Control

DESCRIPTION (cont)

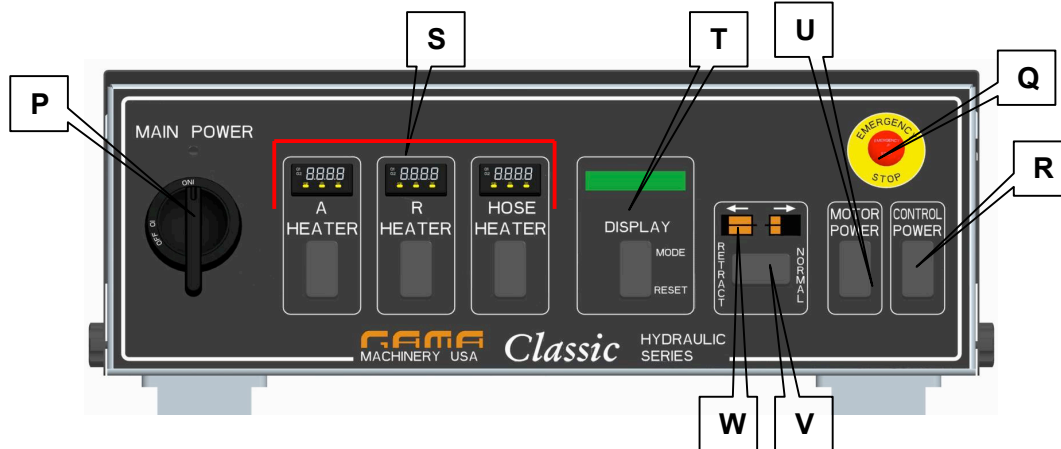

Figure 3
Control Panel

- P. Main Power** - Turns ON and OFF main power to the control panel. It must be turned ON for any operation to be performed with the unit. When turned ON, the red pilot will light.
- Q. Emergency Stop** - Interrupts complete GH- Series control power circuit thus allowing NO power to the Heaters, Hose or Motor.
- R. Control Power** – The Control Power Switch only controls the 24 Volt DC necessary for any proportioner functions to operate. In the on position the temperature controllers will display ambient temperature and the main machine display will illuminate.
- S. Heater Temperature Zones, A (Iso), R (Poly), HOSE** - Turns ON and OFF power to the specific Heaters. See page 20 for detailed Temperature Controller instructions.
The Hose Heater Controller automatically controls the Hose Heater only when using the TSU (Temperature Sensing Unit) probe.
- T. Display** – Upon initial power-up displays **Check PMC Pump Lube**
Dual lines display:
 - Number of Pump Line Cycles/Hours of Operation
 - Hose Amperage/Hose Voltage Depress and hold MODE button to display:
 - Accumulated Pump Line Cycles/Accumulated Hours of Operation
 - Line Voltage (L1, L2, L3 for 3 phase)
Hold the RESET button for 5 seconds to zero Pump Line Cycles
Hold the RESET button for 15 seconds to zero the Hours of Operation
Accumulated totals cannot be reset
- U. Motor Power** - Turns ON and OFF the Electric/Hydraulic Motor. When turned ON, the red pilot will light. In the event of an overload of the Motor, pilot light will turn OFF and Motor will stop.



Classic GH-40 Manual

DESCRIPTION (cont)

V. Pump Switch

Off - Removes power from the pump circuit. The red directional indicator lights will not be lit.

Normal - Activates the normal operation of the machine. When the switch is ON, the red directional light corresponding to the stroke direction will light.

Retract - Sets the Piston Rod of the Iso (A) metering pump to the retract position and prevents the crystallization of Iso (A) on the Piston Rod. Press the RETRACT key every time the unit is stopped by the operator (see Shut-Down, page 21). When the switch is ON, the red directional light will light.

W. Direction Indicator Light - Indicates the movement direction of the Metering Pumps. If excessive pressure is caused in the system, the pump circuit will be disabled and the red directional lights will be OFF.

Installation

WARNING! Use suitable protection and follow the recommendations in the Safety Information enclosed and provided by material suppliers when installing or working with the proportioner.

Inside the console is a Terminal Strip for connecting the incoming power cable (not supplied). Use appropriate AWG wire. The electrical connection of the proportioner must be carried out by a \geq d electrician.



E: To ensure the GH Series Proportioner works correctly, the electrical supply must meet the conditions indicated on the Serial Number Placard affixed to the Electric Console.

CAUTION! Make sure the power cable is disconnected from the main power source before connecting to the Terminal Strip in the Console.

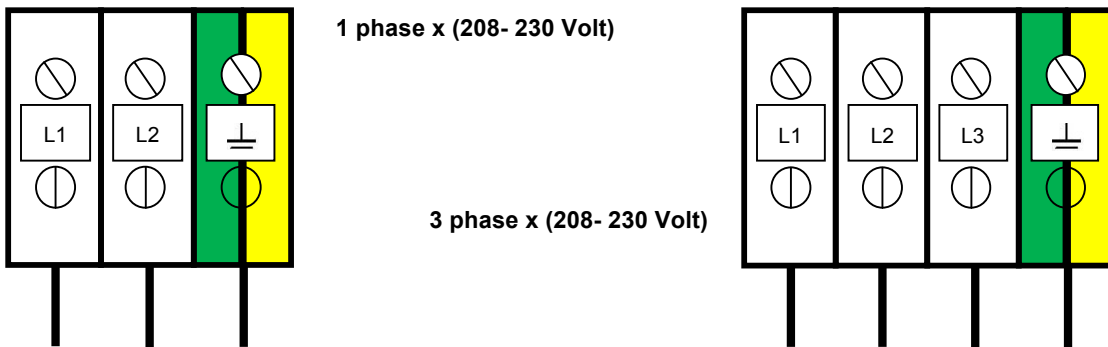

Follow the recommended procedure in the indicated order to install the proportioner:

1. Insert the main power cable by passing it through the strain relief at the bottom of the Electrical Console and connect as shown in the above diagram.
2. Fill the Hydraulic Reservoir with 20 gal of approved hydraulic fluid. See page 43 for specifications.

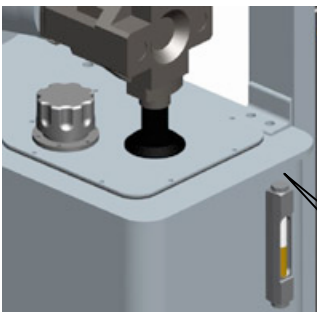

Figure 4
Hydraulic Fill/Level
Indicator

NOTE: Do not fill the tank to maximum capacity; use the Visual Level Indicator [Z] on the tank to make sure the amount of hydraulic fluid is not more than 20 gal or 80% of the tank maximum capacity.

3. Check the level of the hydraulic fluid in the Hydraulic Pump Case: Disconnect the Hydraulic Hose from the 90° Fitting and remove Fitting from Hydraulic Case. Add fluid as required to the top of threaded hole. Reattach Fitting and Hydraulic Hose.



Classic GH-40 Manual

Installation (cont)

4. **Three-phase Proportioner Only:** Check the Electric Motor to ensure rotation is **clockwise** when viewing the Fan end of the Electric Motor. A counter clockwise rotation indicates two of the incoming power leads need to be reversed.

CAUTION! *Ensure Main Power switch is OFF and incoming power is locked OFF before reversing power leads.*

Recheck rotation before proceeding with Installation.

5. Fill the Lube Reservoir (Figure 5) with Pump Lube or suitable diluent. It is not necessary to prime the system.

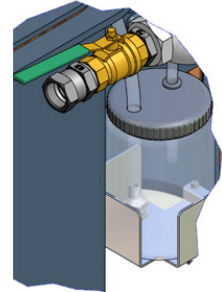

Figure 5
Iso Lube Reservoir

Heated Hose Installation

CAUTION! *The material delivery Heated Hoses are color coded Red and Blue allowing the user to recognize them. The Red corresponds to the Isocyanate (Iso, A) and the Blue to the Polyol (Poly, R). To avoid connection errors the Coupling Connections of the Iso (A) and Poly® Heated Hoses are also different sizes, which makes it difficult to swap connections.*

NOTE: *The material delivery Heated Hoses are capped at the ends to prevent absorbing moisture. Do not remove caps until the Heated Hoses are going to be installed on the proportioner.*

1. Lay out all the Heated Hose assemblies end to end aligning the Iso (red) and Poly (blue) and connect the respective Coupling Connections using the appropriate sized open-end wrench after ensuring Heated Hose assemblies lay flat.

CAUTION! *Take care to not cross-thread or over-tighten the Coupling Connections. Thread seal tape or compound is not required for this tapered seat Coupling Connections.*

2. Connect the material Heated Hoses to the outlets of the respective Heaters (i.e. Iso (A) Heated Hose to the Iso (A) Heater and the Poly® Heated Hose to the Poly® Heater) ensuring Heated Hose assemblies lay flat.
3. Connect Air Hose Coupling Connections.

Installation (cont)

Heated Hose Installation (cont)

4. Connect the Heated Hose power wires to the “Fast-Lock” Connector coming from the Hose Heat Transformer as follows:
 - a. Loosen the Socket Head Set Screw to allow insertion of the Heated Hose electrical wire Terminal.
 - b. Insert the Terminal into the “Fast-Lock” Connector Body.
 - c. Securely tighten the Socket Head Set Screw.
 - d. Install electrical tape around Connector Body.

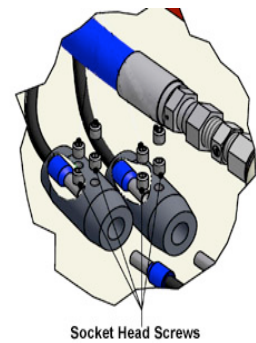

Figure 6
Fast-Lock Connection
Part # HI-05020

NOTE: A good practice is to add some dielectric grease (Permatex 67VR or equivalent) to the outside of the Terminal prior to insertion.

Repeat the above steps to connect the “Fast-Lock” Connectors that you will find on all Heated Hose power wire. NOTE: All PMC heated hose wire is #6 AWG.

CAUTION! Ensure the proper mechanical and electrical connections of the Heated Hoses are made to avoid possible material leakage and hose heat problems.

5. It is recommended the TSU be installed between the last section of Heated Hose and the Gun Whip. Carefully straighten the sensing wire, inserting it in the Iso (A) Heated Hose and tighten fluid fittings with appropriate sized open-end wrenches.

CAUTION! To protect the TSU sensor, you must pay special attention not to kink or excessively bend the Heated Hoses. Do not coil the Heated Hoses with a diameter of less than 4 feet.

CAUTION! Connecting the TSU between the first and second section of Heated Hose results in the TSU sensing the material temperature exiting the Heater and not the inside of the Heated Hose near the Spray Gun.



Figure 7
Temperature Sensing Unit
(TSU)



Classic GH-40 Manual

Installation (cont)

Hose Heat Transformer

The Hose Heat Transformer offers the ability of connecting to different output voltages depending on the total length of the Heated Hose in use, maximizing the heating ability of the Heated Hose. The factory setting is 120 volts for use with 410 feet of Heated Hose. Before starting the proportioner, ensure the setting matches the Heated Hose length installed. If Heated Hose sections are added or removed, the Tap setting should be changed to a setting which will limit the maximum amperage in the Heated Hose to 52 amps. The suggested settings are tabled below:

Tap	Length
120v	410'
105v	360'
90v	310'
75v	260'
60v	210'
45v	160'
30v	110'
15v	60'

Figure 8
Hose Heater
Transformer

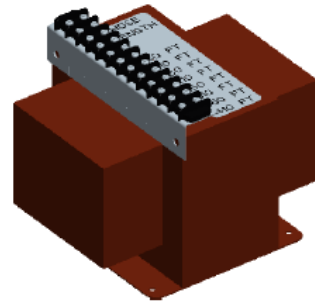

6. Ensure the Manual Valves are CLOSED and connect the Coupling Block to the Heated Gun Whip.

CAUTION! Excessive force closing or opening the Manual Valves may result in damage to the Manual Valves and/or Coupling Block.

7. Connect the Transfer Pump/ Heated Hose Assemblies air supply and air dryer systems as required. Review the Installation Instructions for each to ensure proper set-up and operation.
8. Install the Material Transfer Pumps as follows:

WARNING! If Transfer Pumps have been previously used, pay special attention to connect each Pump to "its" specific material. Inadvertently changing the Transfer Pumps will cause a chemical reaction rendering them useless.



Figure 9
Transfer Pump

Installation (cont)

NOTE: *Placing a tape of the same color as of the Material Delivery Hoses (red for the Iso (A), blue for the Poly ®) on each Transfer Pump would be a good method for minimizing errors in connection.*

- a. Make sure that the Inlet Valves on the Proportioner are closed.
- b. Connect one end of the Polyol ® Material Delivery Hose (¾" thread)
- c. to the proportioner Polyol ® Inlet Valve and the other end to the Polyol ® Transfer Pump.
- d. Connect one end of the Iso (A) Material Delivery Hose (½" thread) to the proportioner Iso (A) Inlet Valve and the other end to the Iso Transfer Pump.
- e. Connect the air hose to the Transfer Pumps after ensuring each Transfer Pump Shut-Off Valve is CLOSED.

NOTE: *To avoid errors in connection, the Coupling connections of the Iso (A) and Poly ® Material Delivery Hoses are different sizes, making it difficult to swap connections.*

- e. Ground the Transfer Pump as recommend by the material supplier. The movement of product inside the Hoses can cause static electricity and produce electrical discharges.



Classic GH-40 Manual

PROPORTIONER PURGING



WARNING! Use suitable Personal Protection Equipment (PPE) and



follow the recommendations in the Safety Information provided by product suppliers when installing or working with the unit.

NOTE: Before using the Proportioner it is necessary to purge the entire system, including Heated Hoses of mineral oil left over from Quality Control testing and air. The following procedure is also followed to purge air entrapped by running out of material in the supply Drum/Reservoirs resulting in a significant indicated material pressure imbalance as indicated by the Pressure Gauges and sprayed material.

1. Ensure the following before proceeding:
 - a. Air supply to Transfer Pumps is 90 - 110 psi.
 - b. Proportioner Inlet Valves are CLOSED.
 - c. All connections are tight.
 - d. Material should be stored to the material suppliers' recommended temperatures.
2. Slowly OPEN the Poly ® Transfer Pump Air Shut-Off Valve allowing Pump to cycle slowly as it fills the Material Delivery Hose to the Proportioner. Check for leaks.
3. OPEN Poly ® Coupling Block Manual Valve over a waste container.
4. Slowly OPEN Proportioner Poly ® Inlet Valve allowing Transfer Pump to move material through the system. When all spitting of air stops and all traces of mineral oil have disappeared, CLOSE Poly ® Coupling Block Manual Valve. Clean Coupling Block.
5. Repeat steps 2 to 4 for Iso (A) side.

CAUTION! Properly dispose of all waste chemicals in accordance with all applicable local, state and federal codes.

6. Turn Hydraulic Pressure Control [N, page 10] full COUNTERCLOCKWISE.
7. Turn ON Main Power [P, page 11]. Red pilot will light.
8. Turn ON Control Power [R, page 11]. Red pilot will light.
9. Turn ON Motor Power [U, page 11]. Red pilot will light.
10. Set Pump Switch [V, page 11] to NORMAL. Turn Hydraulic Pressure Control CLOCKWISE increasing material pressure to 400 psi. Both Material Pressure Gauges [H, K, page 9] should read the same. Check all Heated Hose Coupling connections for leakage.
11. Check all TSU and "Fast-Lock" connections for leaks.
12. Bundle all Heated Hose Connections ensuring no TSU Cable or Air Hose kinks. Wrap with Electrical Tape to securely hold all components in place and minimize places for bundle to snag onto job site protrusions.

DIGITAL TEMPERATURE CONTROLLER







The GH- Series has three Digital Temperature Controllers to manage the temperatures for the Primary Heaters (Iso (A), Poly ®) and the Heated Hose. The Hose Heater Controller is programmed different from the Iso (A) and Poly ® Controllers and therefore not interchangeable with them.

WARNING! Do not turn the Temperature Controllers ON until the Proportioner Purging procedure is complete and the Primary Heaters and Heated Hoses are filled with material.

1. Ensure Main Power [P, page 11] is ON, Control Power [R, page 11] is ON and 01 Display light.



Figure 10
Temperature Controller

2. Press and release  button. The display will read **SP1**.
3. Press and release  or  button to display the **current material temperature set-point**.
4. Press and hold the  or  to **increase** or **decrease** the material temperature set-point to the desired value as determined by the material supplier or application conditions.
5. Press and release  and  together to display the **actual material temperature** in the Primary Heater/Hose Heater.

WARNING! The Controllers are factory programmed and are not field re-programmable. If a problem is encountered, contact PMC Technical Service. Do not attempt to change any of the programmed parameters. Do not substitute a Controller from an alternate supplier as its use may result in equipment damage and/or bodily injury.

NOTE: The Temperature Controller normally displays the actual material temperature. When lit, the red “01” display in the upper left indicates power is being sent to the Heater. The “01” display goes out when the material temperature has reached its set-point. The “01” display will continue to cycle on and off indicating the Controller is maintaining the material temperature set-point.



Classic GH-40 Manual

START-UP

NOTE: Follow the recommended procedure in the order shown.

CAUTION! The Start-up procedures assume that all of steps in Proportioner purging have been performed and no problems found.

1. Check the condition of the DOP in the Iso (A) Lube Reservoir (Figure 5, page 14). Replace the DOP if you see significant changes in the color or signs of solidification. Ensure inside of Reservoir is wiped clean.
2. Check the hydraulic fluid level and service as required.
3. Make sure the materials have been stored at the manufacturer's recommended temperature. Ask your material supplier for information (Material Data Sheet) on the minimum storage temperature.
4. Connect air supply to the two Transfer Pumps and ensure Air Valves are in the full OPEN position. OPEN both Proportioner Material Inlet Ball Valves.

CAUTION! Remove all Heated Hose sections from coiled storage and lay flat to eliminate heat build-up and possible Heated Hose failure.

5. Turn ON Main Power [P, page 11].
6. Turn ON Control Power [R, page 11].
7. Turn ON Hose Heater and confirm material set-point temperature as recommended by the material supplier or application conditions.

CAUTION! To avoid excessive pressure in the Proportioner, wait for the Hose Heater to reach its set-point temperature before continuing.

8. Turn ON each Primary Heater and confirm material set-point temperature as required by the material supplier or application conditions has been reached.
9. Turn ON Motor Power [U, page 11].
10. Set Pump Switch [V, page 11] to NORMAL. One of the Directional Indicator Lights [W, page 11] will light indicating Metering Pump direction and the Metering Pump Shafts will begin to move.

NOTE:

- a. The Material Pressure Gauges [H, K, page 9] should be approximately equal and remain constant throughout Metering Pump cycle. If not, refer to Trouble Shooting section.
 - b. Directional Indicator Lights must indicate Metering Pump direction when Pump Switch is in the NORMAL position. If not, refer to Trouble Shooting section.
11. Using the Hydraulic Pressure Control, adjust to the required stall pressure^① and check each Material Pressure Gauge.
 12. Proceed with Installation and Start-up of the Spray Gun, Manual MN-04002/page 10.

① Stall pressure: When materials are at recommend application temperature and Metering Pumps are pressurized but not moving. This pressure is normally 100 – 200 psi greater than the developed spray pressure as recommended by the material supplier.

SHUT-DOWN

Follow the recommended procedure in the indicated order for Proportioner temporary shut-down such as **lunch breaks**.

1. Set Pump Switch [V, page 11] to OFF position.
2. Turn each Heater OFF. Hose Heater should remain ON. Never leave Proportioner ON if unattended.
3. CLOSE Spray Gun Manual Valves.

CAUTION! Excessive force opening or closing the Manual Valves may result in damage to the Manual Valves and/or Coupling Block.

Follow the recommended procedure in the indicated order for Proportioner shut-down when work is **stopped for the day**.

1. Set the Pump Switch [V, page 11] to RETRACT.
2. Spray off the application surface until Material Pressure Gauges [H, K, page 9] readings begin to fall.

CAUTION! To avoid possible Proportioning Pump Seal seepage, and moisture vapor drive into the Heated Hoses, the system pressure should not be reduced to zero. It is recommended to lower the system pressure to a minimum of 400 psi.

3. CLOSE the Spray Gun Coupling Block Manual Valves.

CAUTION! Excessive force opening or closing the Manual Valves may result in damage to the Manual Valves and/or Coupling Block.

4. Turn OFF Motor Power [U, page 11].
4. Turn OFF the A and R Heaters and Hose Heater [S, page 11].
5. Turn OFF the Control Power [R, page 11].
6. Turn OFF the Main Power [P, page 11].
7. Disconnect the air supply to the two Transfer Pumps and CLOSE the Proportioner Material Inlet Valves.



Classic GH-40 Manual

TROUBLESHOOTING

The GH Series proportioner has been designed and built to withstand severe working conditions with a high degree of reliability, provided that it is used in a suitable application by a properly trained operator. This chapter contains information on possible faults that may interrupt the operation of the GH Series. The information provided will serve as a guideline to detect and resolve problems. In any case, feel free to contact the Technical Service group of PMC, where a qualified technician will advise you.

CAUTION! All repairs performed by unqualified personnel or the use of spares other than originals may cause damage to the unit and put the operator at risk.



To prevent possible injury caused by incorrect handling of the raw materials and solvents used in the process, carefully read the Material Safety Data Sheet (MSDS) provided by your supplier.
Deal with waste caused according to current regulations.
Pour éviter toute blessure causée par une mauvaise manipulation des matières premières et les solvants utilisés dans le processus, veuillez lire attentivement la fiche signalétique (MSDS) fournies par votre fournisseur.
Traiter les déchets causés selon la réglementation en vigueur.



To avoid damage caused by the impact of pressurized fluids, do not open any connection or perform maintenance work on the components subject to pressure until the pressure has been completely eliminated.
Pour éviter les dommages causés par l'impact des fluides sous pression, ne pas ouvrir un lien ou d'effectuer des travaux d'entretien sur les éléments soumis à la pression jusqu'à ce que la pression a été complètement éliminé.



Use suitable protection when operating, maintaining or being present in the area where the equipment is functioning. This includes, but is not limited to, the use of protective goggles, gloves, shoes and safety clothing and breathing equipment.



Utiliser une protection appropriée utilisation, d'entretien ou d'être présents dans la région où le matériel fonctionne. Cela inclut, mais n'est pas limité à, l'utilisation de lunettes de protection, gants, chaussures et vêtements de sécurité et un équipement respiratoire.



The equipment includes components that reach high temperatures and can cause burns. Hot parts of the equipment must NOT be handled or touched until they have cooled completely.
L'équipement comprend des éléments qui atteignent des températures élevées et peuvent provoquer des brûlures. Les parties chaudes de l'équipement ne doit pas être manipulé ou touché jusqu'à ce qu'ils aient complètement refroidi.



To prevent serious injury through crushing or amputation, do not work with the equipment without the safety guards installed on the moving parts. Make sure that all the safety guards are correctly reinstalled at the end of the repair or maintenance work of the equipment.
L'équipement comprend des éléments qui atteignent des températures élevées et peuvent provoquer des brûlures. Les parties chaudes de l'équipement ne doit pas être manipulé ou touché jusqu'à ce qu'ils aient complètement refroidi.

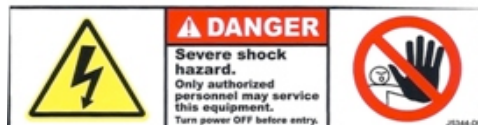

TROUBLESHOOTING

Heaters

WARNING! Before troubleshooting make sure the Main Power Switch is OFF and incoming power is locked OFF. NEVER access the inside of the Control Panel with the Proportioner power supply ON. The Heaters are components that reach high temperatures; you must wait until they cool before handling.

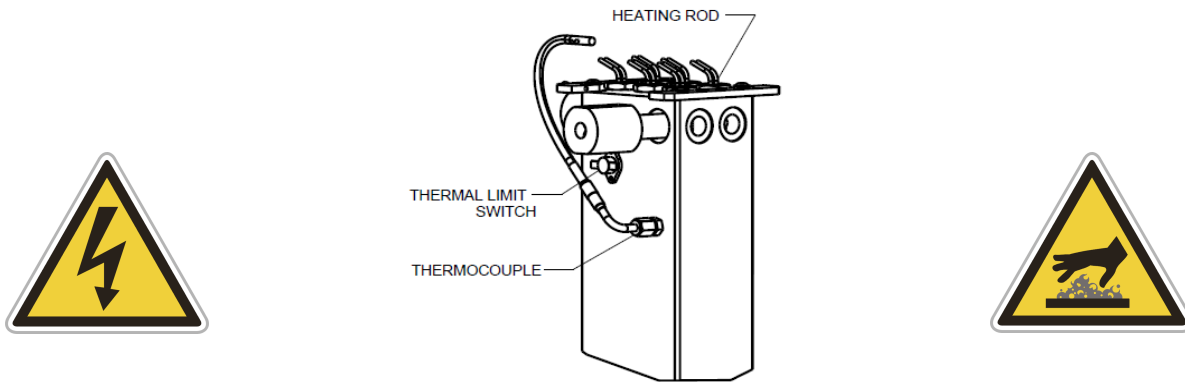

Figure 10.
Material Heater

NOTE: The Thermal Limit Switch is a safety switch in contact with the Heater body. If the surface temperature exceeds 220° F the Limit Switch will shut off the Heater power. The Limit Switch will not reset until the temperature in the Heater is below 190° F.

Follow the recommended procedure in the indicated order to solve the problem and avoid unnecessary repairs. Make sure all Switches are in the correct position and Indicator Lights ON before determining the existence of a fault.

PROBLEM SOLUTIONS

Heater Circuit is interrupted	5
Heater does not heat; 01display light on Digital Controller is not ON	1,2
Heater does not heat; 01display light on Digital Controller is ON	1,2,4
Heater partially heats; 01display light is ON continuously	6,4,7
Digital Temperature Controller display shows the symbol SbEr	3
Digital Temperature Controller display shows Error Code	Contact PMC Technical Service



Classic GH-40 Manual

TROUBLESHOOTING

Heaters (cont)

SOLUTIONS

1. Digital Temperature Controller (DTC)

The DTC for both Material Heaters are interchangeable. To determine if a Heater DTC is operating correctly; ensuring Main Power is OFF, interchange both Primary Heater DTC and determine if problem follows the suspected DTC. If it does, replace the defective DTC.

2. Solid State Relay (SSR)

It is not possible to check for normal operation of the SSR without electrical power. Ensuring Main Power is OFF; remove the wire from Terminal #1 on the SSR. Check for continuity across Terminals #1 and #2. If continuity is present, and all other testing fails to determine problem, it must be assumed the SSR is inoperative and must be replaced.

3. Thermocouple/Temperature Sensor Unit (TSU)

The Material Heaters use Thermocouples to send the material temperature to the DTC. If the DTC does not receive this signal it will automatically shut-down and show an Error Code. Refer to the Maintenance section of this Manual for replacement of the appropriate thermocouple.

Proper operation of the Thermocouple is dependent on two conditions:

- a) The Thermocouple **must** make positive contact with the Heating Rod
- b) The Heating Rod must be operating correctly

Lack of either of these conditions will result in erratic temperature control and possible overheating. The Thermocouple is properly positioned and locked into place at the factory. However, during changing of the Thermocouple or Heater Rod, the positioning may change. Refer to the Maintenance section for proper Thermocouple positioning.

4. Heating Rod

To check the operation of the Heating Rods, proceed as follows with Main Power OFF:

7.5kW Heater: Use a tester to check that the total resistance of all the Heating Rods is **9.25** ohms; a higher value would indicate that one or several of the elements are faulty. Disconnect them and check that the individual value of each Heating Rod is **55.5** ohms.

9kW Heater: Use a tester to check that the total resistance of all the Heating Rods is **7.83** ohms; a higher value would indicate that one or several of the elements are faulty. Disconnect them and check that the individual value of each Heating Rod is **47** ohms.

TROUBLESHOOTING

Heaters (cont)

5. Thermal Limit Switch

A separate over-temperature safety circuit with a Thermal Limit Switch is attached to each Material Heater. When the Heater surface temperature exceeds 220°F, the Limit Switch will automatically interrupt the Heater Control Circuit. Allow the temperature of the Material Heater to cool to a safe temperature before determining over-heat problem and correcting.

CAUTION! Do not attempt to reset the Heater Circuit Breakers more than twice. Failure of the Circuit Breaker safety mechanism will occur and the Circuit Breaker will become inoperable. The cause of the problem must be determined and corrected.

6. Low Line Voltage

Material Heater ratings are at 220 volts. Lower than 220 volts will reduce the heating capability of the Material Heaters and Hose Heater.

7. Excessive ΔT

The PMC GH Series of Material Heaters are designed to offer maximum heat transfer based on power (voltage), Proportioner output (lb/min, gal/min) and desired material temperature increase. This heat transfer number is easiest defined as temperature delta (ΔT in °F). If the Material Heaters are unable to obtain the desire spray temperature due to a number of reasons, the output of the Proportioner can be reduced by using a smaller Mixing Chamber (Nozzle). Contact PMC Technical Service for more information.



Classic GH-40 Manual

TROUBLESHOOTING

Hydraulic Drive System

Follow the recommended procedure in the indicated order to solve the problem and avoid unnecessary repairs. Make sure all Switches are in the correct position and Indicator Lights ON before determining the existence of a fault.

PROBLEM SOLUTIONS

Motor Power Switch trips OFF	1
Hydraulic Pump does not develop pressure	2
Low or zero hydraulic pressure with unusual Hydraulic Pump noises	2d, 3

WARNING! Before correcting any kind of defect, make sure the Main Power Switch is OFF and incoming power is locked OFF. NEVER access the inside of the Control Panel with the Proportioner power supply ON. The Hydraulic Unit is a component that works under pressure. Do not open any connection or carry out maintenance on components subject to pressure until all pressure has been bled to zero.

SOLUTIONS

1. Motor Contactor Safety

The Electric Motor is protected from excessive current by an Overload Safety Switch. After allowing the Motor to cool, open the Control Panel and reset Motor Contactor Safety.

CAUTION! Do not attempt to reset the Motor Contactor more than twice. Failure of the Motor Contactor safety mechanism will occur and the Contactor will become inoperable and/or the Motor damaged. The cause of the problem must be determined and corrected.



Figure 12.
Motor Contactor

2. Hydraulic Power Package

NOTE: Hydraulic pressure is not generated if the Motor Power Switch [V, page 11] is OFF or the Pump Switch [W, page 11] is in the OFF position.

TROUBLESHOOTING

Hydraulic Drive System (cont)

With the Pump Switch in the NORMAL position, the failure of the Hydraulic Pump to develop pressure is loss of pump suction (prime). To ensure positive prime, check the following:

- a) Motor rotation (page 14, item 4.).
- b) Hydraulic Reservoir is filled with the proper hydraulic oil and to the correct level (page15, item 2.).
- c) Hydraulic Pump Case is filled with the proper hydraulic fluid (page 15, item 3.).
- d) Loose Inlet Plumbing: Check that all inlet plumbing to Hydraulic Pump is tight ensuring no air leakage into the hydraulic system.

3. Hydraulic Oil

The use of an incorrect hydraulic fluid can result is unusual noises from the pump, excessive wear and moisture absorption. Ensure the hydraulic oil used is from the list on page 43.

In addition to the above, continuous excessive hydraulic oil temperature as well as failure to change the hydraulic oil on a yearly basis will cause the oil to fail and result in excessive Hydraulic Pump wear and unusual noises.



Classic GH-40 Manual

TROUBLESHOOTING

Metering Pump Line

Follow the recommended procedure in the indicated order to solve the problem and avoid

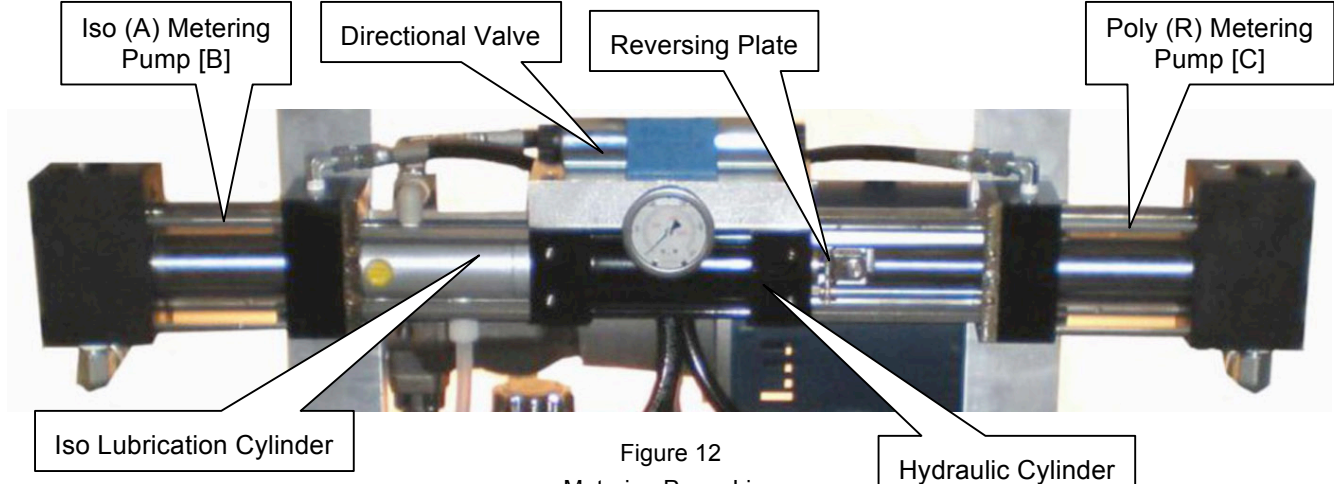

Figure 12

Metering Pump Line

unnecessary repairs. Make sure all Switches are in the correct position and Indicator Lights ON before determining the existence of a fault.

PROBLEM SOLUTIONS

Metering Pumps do not change direction	1
Metering Pumps reversal erratic	1
Metering Pumps fail to move and Direction Indicator Light is OFF	1, 2
Metering Pump moves beyond normal reversal point and stalls	1
Material Pressure Gauges show significant pressure difference	3, 4
Metering Pump fails to hold pressure when Proportioner stalled	4

SOLUTIONS

1. Reversing Switch/Directional Valve

The Metering Pump Line has a Reversing Plate which actuates two Reversing Switches, one at each end of the stroke. The Reversing Switches in turn actuates the appropriate Directional Valve Solenoid.

Failure to make contact with either Reversing Switch may be caused by:

- ✓ Deformation of the Reversing Plate.
- ✓ Foreign material preventing the Reversing Plate from contacting the Reversing Switches.



Inspect

and

correct

issue

TROUBLESHOOTING

Metering Pump Line (cont)

Passing of the Reversing Plate beyond the Reversing Switch may be caused by:

- ✓ Failure of the Reversing Switch [P/N EL-00020] on the side of the over-run.
- ✓ Failure of a component of the Direction Valve.
- ✓ Mounting Plate and/or Reversing Switch is out of adjustment.

Note! *Follow the recommended procedure in the indicated order to solve the problem and avoid unnecessary repairs. Make sure all Switches are in the correct position and Indicator Lights are ON as specified before determining the existence of a fault.*

- a) Ensure Pump Switch [V, page 11] is OFF.
- b) Determine which direction the Reversing Plate must move to be centered. For example, the Plate overran to the Iso (A) Pump [B, page 9] and requires moving towards the Poly ® Pump [C, page 9].
- c) Go to the Directional Valve and locate the Actuation Coil closest to the Poly ® Pump.
- d) With Pump Switch OFF, bleed material through the Spray Gun bringing the material pressures **almost** to zero (below 100 psi).
- e) Main Power [P, page 11] ON, Control Power [R, page 11] ON, Motor Power [U, page 11] ON, Pump Switch [V, page 11] NORMAL, and the Spray Gun Manual Valves OPEN. Trigger Spray Gun ON.
- f) Push in the Directional Valve Manual Override (a 3/16" Allen Wrench is recommended) until Reversing Plate is approximately centered. Release Manual Override, trigger Spray Gun OFF and CLOSE Spray Gun Manual Valves.

If the Manual Operator moved smoothly the cause of the over-run was probably electrical.

- g) Turn Main Power [P, page 11] ON, Control Power [R, page 11] ON, Motor Power [U, page 11] **OFF**, Pump Switch [V, page 11] NORMAL. Push IN each Reversing Switch Actuation Arm and listen for Directional Valve shift. Note the correct Direction Indicator Lights [W, page 11] on the Pump Switch lights.

If the Directional Valve does not shift and/or Direction Indicator Lights do not light up appropriately, there is a problem with the Reversing Switches [P/N EL-00020], Directional Valve Coil or Pump Switch [V, page 11].

If the Manual Operator is hard or unable to push, it is likely there is a mechanical problem with the Directional Valve requiring disassembly for service.



Classic GH-40 Manual

TROUBLESHOOTING

Metering Pump Line (cont)

2. Safety Pressure Switch

Each Metering Pump has a Safety Pressure Switch [I, L, page 9] set to 2,200 psi. for #120 pumps, 3,200 psi for #80 pumps. When the material system reaches this pressure, the Safety Pressure Switch will remove power from the Directional Valve and Direction Indicator Lights [W, page 11]. Lack of Direction Indicator Lights along with high pressure indicated on one or both of the material Pressure Gauges [H, K] is an indication of an over-pressure condition. The Safety Pressure Switches are a momentary design; when the pressure bleeds off the Metering Pump Line will resume normal operation. However, the cause of the over-pressure should be determined and corrected. The three most common causes are:

- a) Cavitation of the Metering Pump on the **low** pressure side causing high pressure on the opposite side.
- b) A restriction in the Spray Gun on the **high** pressure side.
- c) Hydraulic pressure set too high for Spray Gun Mixing Chamber.

3. Pressure/Material Imbalance

In summary troubleshooting this problem requires the applicator to:

- a) Know what the NORMAL spray pressures are for the application in progress.
- b) Determine what material is NOT exiting the Mixing Chamber.
- c) Read the Pressure Gauge on the problem side and interpret the reading.

In this example a lack of Iso (A) with fluctuating LOW pressure on the Iso (A) side indicates the Metering Pump **is not** developing sufficient pressure or material volume; **Cavitation**.

In this example a lack of Poly ® with HIGH pressure on the Poly ® side indicates the Metering Pump **is** developing sufficient pressure; a stoppage after the Pressure Gauge is not allowing the material to exit the Spray Gun.

Check Spray Gun for a blockage.

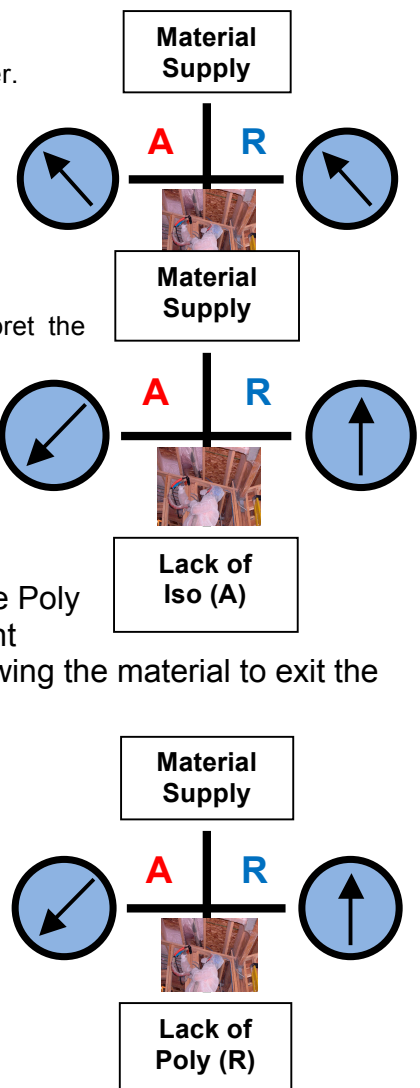

TROUBLESHOOTING

Metering Pump Line (cont)

3. Cavitation

Cavitation occurs when the Metering Pump [B, or C, page 9] requires a larger volume of material than the supply system (Transfer Pump) can furnish. This creates a “void” of material in the Metering Pump. The most common causes of cavitation are:

- a) Material temperature **too low** causing increased material viscosity resulting in the inability of the Transfer Pump to maintain sufficient supply to the Metering Pump. This is most common with today’s 245fa blown systems. Ensure the **material** temperature in the drums is no lower than the material suppliers’ recommendation.
- b) Failure to vent the material drum while drawing material out with the Transfer Pump causes a vacuum and cavitation in the Transfer Pump. Ensure the drum is vented to the atmosphere or a Desiccated Air Dyer Kit is installed as recommended by the material supplier.
- c) Air volume insufficient for Transfer Pump or Transfer Pump Air Valve partially closed will limit the ability of the Transfer Pump to operate at its maximum capability.
- d) Inlet Material Screen [O] obstructed (See **MAINTENANCE** section).
- e) Metering Pump Inlet Ball does not seat properly allowing material to flow back into the Material Delivery Hose when the Metering Pump is on the “Discharge” stroke. This causes the volume of material on that Metering Pump to be less on the discharge stroke resulting in intermittent off-ratio material and Pressure Gauge fluctuation.

4. Pressure Loss: Discharge/Inlet Ball

Simultaneous observation of the material Pressure Gauge [H, K, page 9] and Direction Indicator Light [W, page 11] is necessary to determine which direction the Metering Pump fails to maintain pressure. Refer to the chart to determine problem:

	Left Directional Indicator Light ON	Right Directional Indicator Light ON
Iso Pressure Gauge FALLS	Iso Inlet Ball does not seat properly	Iso Discharge Ball does not seat properly
Poly Pressure Gauge FALLS	Poly Discharge Ball does not seat properly	Poly Inlet Ball does not seat properly

In most cases the cause of a leaking Inlet/Discharge Ball is foreign material preventing the Ball from seating properly. If the above steps do not resolve the problem, replace the appropriate Ball, Ball Seat and Ball Seat Gasket.

For service see MAINTENANCE/Metering Pump Line/page 36.



Classic GH-40 Manual

TROUBLESHOOTING

Hose Heating



WARNING! Before correcting any kind of defect, make sure the Main Power Switch is OFF and incoming power is locked OFF. NEVER access the inside of the Control Panel with the Proportioner power supply ON. The Heated Hose are components which reach high temperatures; you must wait until they have cooled before handling.

Follow the recommended procedure in the indicated order to solve the problem and avoid unnecessary repairs. Make sure all Switches are in the correct position and Indicator Lights ON before determining the existence of a fault.

PROBLEM SOLUTIONS

PROBLEM	SOLUTIONS
Hose heats, but fails to reach Set Point temperature	1, 2, 6
Hose does not heat; 01 display light on Digital Controller is not ON	3, 7
Hose does not heat; 01 display light on Digital Controller is ON	2, 3, 4
Digital Temperature Controller display shows the symbol SbEr	5
Digital Temperature Controller display shows Error Code	Contact PMC Technical Service

SOLUTIONS

1. Hose Length

The **GH-40** has been designed to work with a maximum hose length of 410 ft. A longer length will render the heating capacity less effective. Under extreme ambient conditions, the hose heating system may be affected and fail to reach the required temperature.

2. Hose Transformer Tap Setting

The Hose Heat Transformer offers the option of connecting to different output voltages suitable for the number of Heated Hose sections in use. Refer to the Label on the Hose Transformer for the correct Tap settings.

TROUBLESHOOTING

Hose Heating (cont)

3. Hose Heater Circuit Breakers

The Circuit Breaker located inside the Control Panel protects the primary (high Voltage) side of the Hose Heater Transformer.

The Circuit Breaker located on the front of the Hose Heat Transformer protects the secondary side of the Hose Heater Transformer; make sure it is ON, otherwise activate it.

CAUTION! *Do not attempt to reset the Hose Circuit Breakers more than twice. Failure of the Circuit Breaker safety mechanism will occur and the Circuit Breaker will become inoperable and/or the Heated Hose damaged. The cause of the problem must be determined and corrected.*

CAUTION! *The replacement of either Hose Circuit Breaker with one of a different rating may cause damage to the equipment and put the operator at risk.*

4. Solid State Relay (SSR)

It is not possible to check for normal operation of the SSR without electrical power. Ensuring Main Power is OFF; remove the wire from Terminal #1 on the SSR. Check for continuity across Terminals #1 and #2. If continuity is present, and all other testing fails to determine problem, it must be assumed the SSR is inoperative and must be replaced.

5. Temperature Sensing Unit (TSU)

The Temperature Controller automatically detects the operation of the TSU. If this fault occurs, check the wiring to the TSU and Proportioner. Replace as required.

6. Hose Heating Temperature Adjustment

The Hose Heater system is designed to maintain the temperature settings of the Iso (A)/Poly® Heaters. Common practice is to set the Hose Heater setting equal to the Iso (A)/Poly® Heaters setting. The Hose Heater system will not elevate the material temperature under material flow conditions.

7. Digital Temperature Controller (DTC)

The Digital Temperature Controllers (DTC) for the Hose Heater is **not** interchangeable with the Heater DTCs. If a defective Hose Heater DTC is suspected, contact PMC Technical Support.



Classic GH-40 Manual

Maintenance

To achieve maximum output from the GH Series Proportioner, a daily or regular maintenance schedule is required.

Maintenance

Inlet Material Screens [O]

Inspection of the Inlet Material Screens on a daily basis is no longer necessary as long as the following conditions are met.

1. Material drums are stored within the recommended material storage temperature range and drums are not opened prior to installing the Proportioner Material Transfer Drum Pumps.
2. Desiccated air dryers are used to dry replacement air as material is removed from the drums to the Proportioner.
3. Consolidation of old material into a common drum for use is minimized especially the Iso (A).

If the above conditions are met, inspection of the Inlet Material Screens may be done on a **bi-weekly** basis.

NOTE: Inspect and clean Inlet Material Screens before Proportioner start-up. They should not be cleaned after the days operation as the Proportioner should be purged (see page 18) immediately after inspection and cleaning. This is to reduce the risk of moisture contamination, contamination through the reaction with the solvent used in the cleaning operation and cross-over at the Spray Gun due to air entrapment.

To check the Inlet Material Screens, proceed as follows:

CAUTION! *Make sure the Main Power Switch is OFF and incoming power is locked OFF.*

1. CLOSE the Poly ® Proportioner Inlet Valve.
2. Place a suitable container under the Material Inlet Strainer to collect the residual material. Carefully loosen the Strainer Plug allowing the material to drain into the container.
3. Completely unscrew the Strainer Screw.
4. Remove the Seal, Spring and Screen and clean them with a suitable solvent. Dry the parts and ensure the Screen is not obstructed. Replace the Screen if more than 20% of the Screen surface is obstructed by residue.

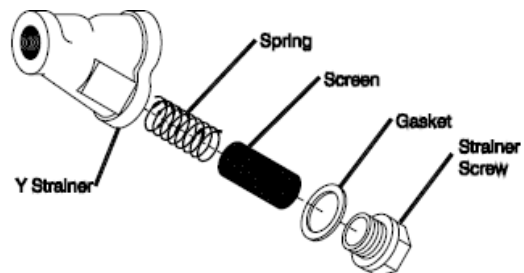

Figure 13.
Material Inlet Strainer

Maintenance

Inlet Material Screens [O] (cont)

5. Reinstall the Screen, Spring and Seal. Screw on the Strainer Screw and screw in Plug.
6. OPEN the Poly ® Proportioner Inlet Valve, pressurize the Material Transfer Pump, check for leaks and wipe Y-strainer clean.
7. Repeat above for the Iso (A) side.
8. Proceed with Proportioner Purging operation (page 18).

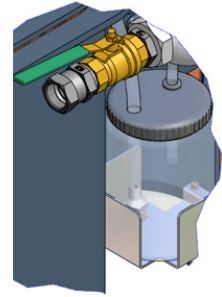

Figure 5.
Iso Lube Reservoir

Iso Lubrication System

Daily: Check the condition of the PMC Lube Oil in the Iso Lube Reservoir. Replace the PMC Lube Oil if you see significant changes in the color or signs of solidification. Ensure inside of Reservoir is wiped clean.

To replace the Lube Oil, proceed as follows:

1. Test spray until the Resin Proportioning Pump is positioned on the **left** hand side. Set the Pump Switch to OFF.
2. Remove the Lube Reservoir from its support, unscrew the Lid and remove the Check Valve of the Suction Hose.
3. Empty the contaminated Lube Oil in a waste container and refit the Check Valve in the Suction Hose.
4. Clean the Reservoir, refill with Lube Oil, and screw on the Lid and replace the Reservoir in its support.

The system is auto-suction and does not need priming.

Hydraulic Drive System

WARNING! Before performing any maintenance, make sure the Main Power Switch is OFF and incoming power is locked OFF. The Hydraulic Unit is a component that works under pressure. Do not open any connection or carry out maintenance on components subject to pressure until all press has been bled to zero.

The hydraulic unit should be serviced **yearly**:

1. Completely drain the Tank of hydraulic fluid.
2. Clean the Tank Top to prevent foreign material from falling into the Tank when the Lid is removed.
3. Unscrew the Suction Pipe from its connection with the Hydraulic Pump.
4. Remove the Lid and Suction Pipe from the Hydraulic Tank. Take care not to damage Tank Lid Gasket.



Classic GH-40 Manual

Maintenance

Hydraulic Drive System (cont)

5. Inspect the bottom of the Tank for sediment and clean as required. Clean the Suction Pipe and its connections.
6. Insert the Suction Pipe into the Tank and replace the Lid. Again, take care not to damage Tank Lid Gasket. Connect the Suction Pipe securely to the Hydraulic Pump.
7. Fill the Tank with 20 gal of approved hydraulic fluid. See page 43 for recommendations.
8. Ensure the Hydraulic Pump Case is full of fluid (Installation, page 13, Item 3) and proceed with the normal operation.

Metering Pump Line

WARNING! Before performing any maintenance, make sure the Main Power Switch is OFF and incoming power is locked OFF. Allow material temperature to cool below 80°F and bleed all material pressure to zero.

Weekly: When the Proportioning Pumps are functioning properly it is not unusual to a small amount of Poly ® material to appear on the Pump Shaft. This material should be wiped away so dirt does not accumulate on the Pump Shaft and the Pump Shaft Packings are not damaged.

Yearly or as required: Assuming the Iso (A) and Poly ® is free from contaminants, the maintenance of the Iso Lube Reservoir (page 36) is performed, and the maintenance of the Poly ® Pump Shaft (above) is followed, the Proportioning Pumps will perform for many maintenance free cycles. However, it is not unusual for those who use the GH- Series Proportioner on a regular basis to rebuild the Proportioning Pumps on a yearly basis and service the Hydraulic Drive System (page 36) at the same time, when the Proportioner is out of service.



Pump Base Service

To service Discharge/Inlet Ball

1. CLOSE appropriate Proportioner Inlet Material Supply Valve and remove Air Line from Transfer Pump.
2. Ensure all material pressure in the Proportioner system is zero and remove appropriate Retainer Plug.
3. For Inlet Ball:
 - a) Remove Inlet Ball with a Magnet, clean Ball and Ball Seat, and inspect for foreign material and flat spot(s) on Ball.
 - b) Using supplied Ball Seat Tool (TL-02), check for proper Ball Seat/Ball Seat Gasket compression. Snug Seat up to ¼ turn **Maximum**.



Figure 14.
Pump Base

Maintenance

Metering Pump Line (cont)

Pump Base Service

4. For Discharge Ball:
 - a) Perform step 1 & 2 from above.
 - b) Remove Cage and Spring.
 - c) Remove Discharge Ball with a Magnet, clean Ball and Ball Seat, and inspect for foreign material and flat spot(s) on Ball.
 - d) Using supplied Ball Seat Tool (TL-02), check for proper Ball Seat/Ball Seat Gasket compression. Snug Seat up to $\frac{1}{4}$ turn **maximum**.

Pump Seal Replacement

Refer to Parts Identification Drawing (pages 46 - 49) for reference.

NOTE:

- ✓ When Iso (A) Proportioning Pump Cylinder is disassembled for service, all parts included in the Seal Kit (KT-05001-120 or KT-05001-080) should be replaced in.
- ✓ When the Poly ® Proportioning Pump Cylinder is disassembled for service, all parts included in the Seal Kit (KT-05002-120 or KT-05002-080) should be replaced.
- ✓ When assembling Proportioning Pump lubricate all Seals, Piston Rod and Pump Cylinder with #1 Lithium Grease to assist in assembly and minimize Seal damage during re-assembly.
- ✓ When the Pump Line End Block is disassembled for service, all O-rings included in the O-ring Kit (KT-05009) should be replaced.
- ✓ After reassembly of the Proportioning Pumps torque the Assembly Bolts to 30 ft/lbs.

CAUTION! Use wooden or plastic tools or a brass brush for cleaning. Do not use metal or abrasive tools that can scratch the contact surfaces.



Classic GH-40 Manual

Maintenance

Material Heater

WARNING! Before performing any maintenance, make sure the Main Power Switch is OFF and incoming power is locked OFF. NEVER access the inside of the Control Panel with the Proportioner power supply ON. The Heaters are components that reach high temperatures; you must wait until they have cooled before handling and bleed all material pressure to zero.



Thermocouple Replacement

Note! The Thermocouple is assembled into the Connector Body with a Ferrule and Nut. Once inserted into the Body and the Nut is tightened, the Ferrule locks to the Thermocouple and does not allow it to be relocated or moved. The location of the Thermocouple is very important and must be done correctly before tightening the Nut.

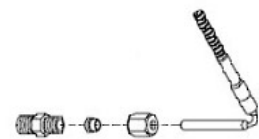

Figure 15
Thermocouple
Assembly

1. Unscrew the Nut that holds the defective Thermocouple and remove from the Body. Disconnect Thermocouple wiring located under the Top Cover of the Heater. Remove Body and discard.
2. Install Heating Element and Spring as directed in page 40, if also removed.
3. Install Connector Body into Heater using an open-end wrench and tighten to prevent leakage. Teflon Tape or appropriate Thread Sealant should be used.
4. Slide the Nut and the Ferrule over the Thermocouple and insert this assembly into the Connector Body until it comes into **positive physical contact** with the Heating Rod. Make sure the Spring does not prevent the Thermocouple from making contact with the Heating Rod.
5. Slowly tighten the Nut using an open-end wrench, ensuring the Thermocouple maintains positive physical contact with the Heating Rod.
6. Reinstall the Thermocouple wires.

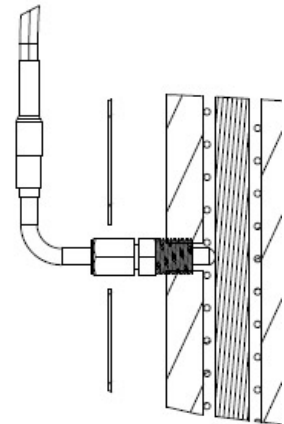

Figure 16
Thermocouple
Positive Contact

Maintenance

Material Heater (cont)

WARNING! Before performing any maintenance, make sure the Main Power Switch is OFF and incoming power is locked OFF. NEVER access the inside of the Control Panel with the Proportioner power supply ON. The Heaters are components that reach high temperatures; you must wait until they have cooled before handling and bleed all material pressure to zero.



Heating Rod

To replace defect Heating Rod proceed as follows:

1. Ensure Main Power Switch is OFF and incoming power is locked OFF. Depressurize proportioner and, remove the Cover on Heater.

Warning! If the Heating Rod to be replaced is the one in contact with the Thermocouple, it is necessary to remove the Thermocouple first (see page 39). Do not loosen or tighten Thermocouple Body.

2. Disconnect the suspect Heating Rod from the wire connections and test Heating Rod again for proper electrical resistance. 5 kW Heating Rod is 37 ohms. 6 kW Heating Rod is 31.3 ohms.
3. Unscrew the Heating Rod and remove from the Heater Block along with its Spring and inspect; it must be smooth and shiny in appearance. If it is blackened or has material adhered to it replace the Heating Rod even if ohm reading is acceptable.
4. Apply Teflon Tape or appropriate Thread Sealant to the Heating Rod thread and assemble Heating Rod and Spring into the Heater Block. Tighten securely to 110 ft/lbs.
5. If necessary carefully re-install Thermocouple ensuring **positive physical contact** with the Heating Rod (see page 39). Make sure the Spring does not prevent the Thermocouple from making contact with the Heating Rod. Tighten Nut with open-end wrench.
6. Reconnect wire connections and replace Cover.
7. Ensure Heater is full of material prior to electrical testing.



Classic GH-40 Manual

REPLACEMENT KITS

120 Iso Pump Rebuild Kit, KT-05001-120

P/N	Description	QTY
OR-00011A	O-ring	2
OR-00020A	O-ring	2
OR-00044A	O-ring	1
OR-00046A	O-ring	2
PU-01002-B12	Cylinder Bearing	1
PU-01013A	Flange Gasket	1
PU-01014A-012	Piston Support Washer	1
PU-01015A-012	Piston Seal Wiper	1
PU-01016A-012	Piston Seal	1
PU-01017A-012	Cylinder Seal	1
PU-05029	Pin	1

120 Resin Pump Rebuild Kit, KT-05002-120

P/N	Description	QTY
OR-00011A	O-ring	2
OR-00046A	O-ring	2
PU-01002-B12	Cylinder Bearing	1
PU-01013A	Flange Gasket	1
PU-01014A-012	Piston Support Washer	1
PU-01015A-012	Piston Seal Wiper	1
PU-01016A-012	Piston Seal	1
PU-01017A-012	Cylinder Seal	1
PU-05029	Pin	1

80 Iso Pump Rebuild Kit, KT-05001-080

P/N	Description	QTY
OR-00011A	O-ring	2
OR-00020A	O-ring	2
OR-00044A	O-ring	1
OR-00046A	O-ring	2
PU-01001-B08	Cylinder Bearing	1
PU-01013A	Flange Gasket	1
PU-01014A-008	Piston Support Washer	1
PU-01015A-008	Piston Seal Wiper	1
PU-01016A-008	Piston Seal	1

PU-01017A-008	Cylinder Seal	1
PU-05029	Pin	1

REPLACEMENT KITS

80 Resin Pump Rebuild Kit, KT-05002-080

P/N	Description	QTY
OR-00011A	O-ring	2
OR-00046A	O-ring	2
PU-01002-B08	Cylinder Bearing	1
PU-01013A	Flange Gasket	1
PU-01014A-008	Piston Support Washer	1
PU-01015A-008	Piston Seal Wiper	1
PU-01016A-008	Piston Seal	1
PU-01017A-008	Cylinder Seal	1
PU-05029	Pin	1

Hydraulic Cylinder Rebuild Kit, KT-05025

P/N	Description	QTY
HI-05025-1	U-Cup	2
HI-05025-2	Back-up Ring, Piston	2
HI-05025-3	Wear Ring	1
HI-05025-4	Rod Wiper	2
HI-05025-5	Shaft Seal	2
HI-05025-6	Back-up Ring, Bushing	2
OR-00019A	O-ring	2
OR-00039A	O-ring	2
OR-00040A	O-ring	2

Proportioning Pump Line O-ring Kit, KT-05009

P/N	Description	QTY
OR-00011A	O-ring	4
OR-00046A	O-ring	4
OR-00045A	O-ring	4
PU-01013A	Gasket	2
OR-00044A	O-ring	1
OR-00020A	O-ring	2

REPLACEMENT KITS



Classic GH-40 Manual

Bleed System, KT-05003

P/N	Description	QTY
GP-00100-1	Nipple	2
GP-00100-2	Ball Valve, 5,000psi	2
GP-00100-4	Pipe Plug	2

Iso Lube Reservoir/Hose Kit, KT-05004

P/N	Description	QTY
MQ-01009-01A	Reservoir Bottle	1
MQ-01009-02A	Reservoir Bottle Lid	2
MA-00024A	Return Tubing	1
MA-00025A	Supply Tubing	2

Heater Thermocouple Kit, KT-05021

P/N	Description	QTY
HI-05020	Body, Nut, Ferrule	1
HI-05021	Thermocouple	1

HYDRAULIC OIL SPECIFICATIONS

Recommended Hydraulic Oil Specification:

ISO/ASTM Viscosity Grade 32

Viscosity: 28.8 – 35.2 SSU@ 104° F

Rust and Oxidation Inhibited

Manufacturers:

Mobil DTE24*	American Oil & Supply – PQ Iso 32	Fiske Bros. – Lubriplate Hyd. #0
Cook's Albavis 8	Gulf Oil – Harmony 32AW (43AW)	SW – Alemite Hydraulic HD#0
Ashland-Valvoline AW15	Atlantic Richfield – Duro AWS-150	Texaco – Rando HD32 (HD A0)
Shell - Tellus 32(25)	BP Oil – Energol HLP-C32	White & Bagley – EP Hyd. 150
Sun Oil - Sunvis 706	Exxon – Nuto H-32(44)	
Chevron ISO32	A. Margolis – T.I.P.100-15-7	

* Preferred